

DENON[®]

AVR-X250BT

AV SURROUND RECEIVER

Owner's Manual

[Front panel](#)[Display](#)[Rear panel](#)[Remote](#)[Index](#)

Accessories	5
Inserting the batteries	6
Operating range of the remote control unit	6
Features	7
High quality sound	7
High performance	7
Easy operation	9
Part names and functions	10
Front panel	10
Display	13
Rear panel	14
Remote control unit	16

Connections

Connecting speakers	20
Speaker installation	20
Speaker connection	22
Standard speaker configuration and connection	24
Connecting a TV	25
Connection 1 : TV equipped with an HDMI connector and compatible with the ARC (Audio Return Channel)	26
Connection 2 : TV equipped with an HDMI connector and incompatible with the ARC (Audio Return Channel)	27
Connection 3 : TV equipped without an HDMI connector	28

Connecting a playback device	29
Connecting a set-top box (Satellite tuner/cable TV)	30
Connecting a DVD player or Blu-ray Disc player	31
Connecting a game console or video camcorder	32
Connecting an FM/AM antenna	33
Connecting the power cord	35

Playback

Basic operation	37
Turning the power on	37
Selecting the input source	37
Adjusting the volume	38
Turning off the sound temporarily (Muting)	38
Playback a DVD player/Blu-ray Disc player	38
Listening to music on a Bluetooth device	39
Playing music from Bluetooth device	40
Pairing with other Bluetooth devices	42
Reconnecting to this unit from a Bluetooth device	43



Listening to FM/AM broadcasts	44
Listening to FM/AM broadcasts	45
RDS search	46
PTY search	47
TP search	48
Radio Text	48
Tuning in to stations and presetting them automatically (Auto Preset)	49
Presetting the current broadcast station (Preset Memory)	50
Listening to preset stations	50
Skipping preset broadcast stations (Preset Skip)	51
Cancelling Preset Skip	51
Convenience functions	52
Performing repeat playback (Repeat)	53
Performing random playback (Random)	53
Adjusting the tone (Tone)	54
Optimizing the night time listening volume (Night Mode)	55
Displaying your desired video during audio playback (Video Select)	56
Selecting a sound mode	57
Selecting a sound mode	57
HDMI control function	61
Setting procedure	61
Adjusting the volume of each channel to match the input source (Ch Level Adjust)	62

Sleep timer function	63
Using the sleep timer	64
Quick select plus function	65
Calling up the settings	66
Changing the settings	66

Settings

Menu map	67
Menu operations	70
Audio	71
Surr.Parameter	71
Restorer	74
Audio Delay	75
Volume	75
Video	77
HDMI Audio Out	77
HDMI PassThrough	77
Pass Source	78
HDMI Control	78
ARC	79
TV Audio Switching	79
Pow.Off Control	80



Inputs	81
Input Assign	81
Source Level	81
Input Select	82
Speakers	83
Speaker Config.	83
Distances	84
Levels	85
Crossovers	85
Bass	86
General	87
Language	87
ECO	87
Bluetooth	89
Front Display	90
Setup Lock	90
Reset	91
Checking the information	92

Tips

Tips	94
Troubleshooting	95
Resetting factory settings	106

Appendix

About HDMI	107
Playing back a Bluetooth device	110
Personal memory plus function	110
Last function memory	110
Sound modes and channel output	111
Sound modes and surround parameters	112
Types of input signals, and corresponding sound modes	113
Explanation of terms	114
Trademark information	119
Specifications	120
Index	124









Thank you for purchasing this Denon product.

To ensure proper operation, please read this owner's manual carefully before using the product.

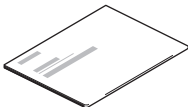
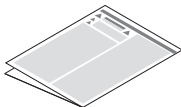
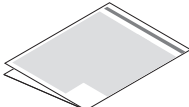
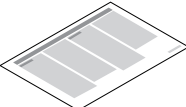
After reading this manual, be sure to keep it for future reference.

Accessories

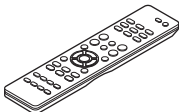
Check that the following parts are supplied with the product.

 Quick Start Guide	 Safety Instructions	 Cautions on Using Batteries	 Notes on radio	 Power cord
 FM indoor antenna	 AM loop antenna	 Remote control unit (RC-1225)	 R03/AAA batteries	



Inserting the batteries

- 1 Remove the rear lid in the direction of the arrow and remove it.

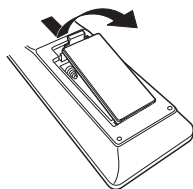

- 2 Insert two batteries correctly into the battery compartment as indicated.

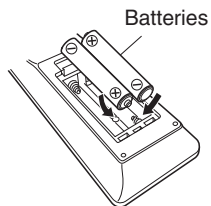

- 3 Put the rear cover back on.

NOTE

- To prevent damage or leakage of battery fluid:
 - Do not use a new battery together with an old one.
 - Do not use two different types of batteries.
- Remove the batteries from the remote control unit if it will not be in use for long periods.
- If the battery fluid should leak, carefully wipe the fluid off the inside of the battery compartment and insert new batteries.

Operating range of the remote control unit

Point the remote control unit at the remote sensor when operating it.

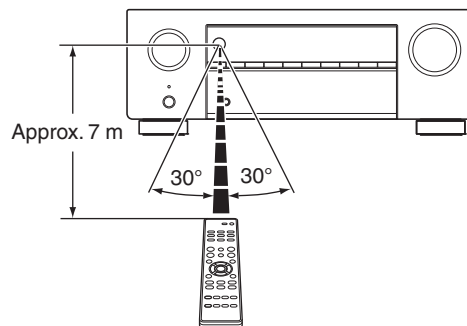

Features

High quality sound

- **With discrete circuit technology, the power amplifier provides identical quality for all 5-channels (90 Watts x 5-channels)**
For optimum realism and stunning dynamic range, the power amplifier section features discrete power devices (not integrated circuitry). By using high current, high power discrete power devices, the amplifier is able to easily drive high quality speakers.

High performance

- **4K 60Hz input/output supported**

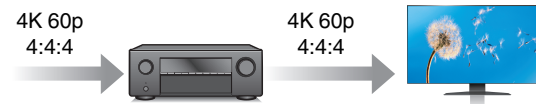

When 4K Ultra HD (High Definition) is used, an input/output speed of 60 frames per second (60p) is achieved for video signals. When connected to 4K Ultra HD and 60p video signal input compatible TV, you can enjoy the sense of realism only available from high-definition images, even when viewing fast-moving video.

This unit also supports image processing for 4K 60p, 4:4:4 and 24-bit videos. By processing the video at the original resolution, this unit lets you enjoy flawless, high-definition picture quality.

This unit also supports HDR (High Dynamic Range) and BT.2020 wide color gamut.

- **HDCP 2.2**
This unit is compatible with HDCP 2.2 copyright protection standard.



- **HDMI connections enable connection to various digital AV devices (5 inputs, 1 output)**

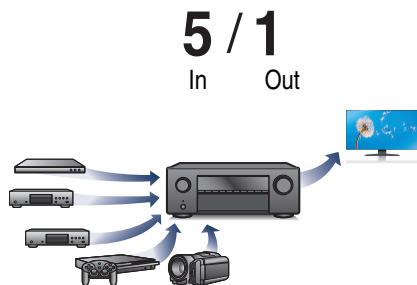

This unit is equipped with 5 HDMI inputs and 1 HDMI output enabling connection to various HDMI compatible devices such as Blu-ray Disc players, game consoles and HD video camcorders.

- **Wireless connection with Bluetooth devices can be carried out easily (☞ p. 39)**

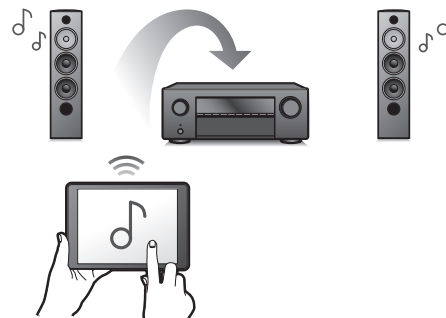

You can enjoy music simply by connecting wirelessly with your smartphone, tablet, PC, etc.

- **Energy-saving design**

This unit is equipped with an ECO Mode function that allows you to enjoy music and movies while reducing the power consumption during use, and also an auto-standby function that automatically turns off the power supply when the unit is not in use. This helps reduce unnecessary power use.



Easy operation

- **“Setup Assistant” provides easy-to-follow setup instructions**

First select the language when prompted. Then simply follow the instructions displayed on the TV screen to set up the speakers etc.

- **Easy to use Graphical User Interface**

This unit is equipped with a Graphical User Interface for improved operability.



Part names and functions

Front panel

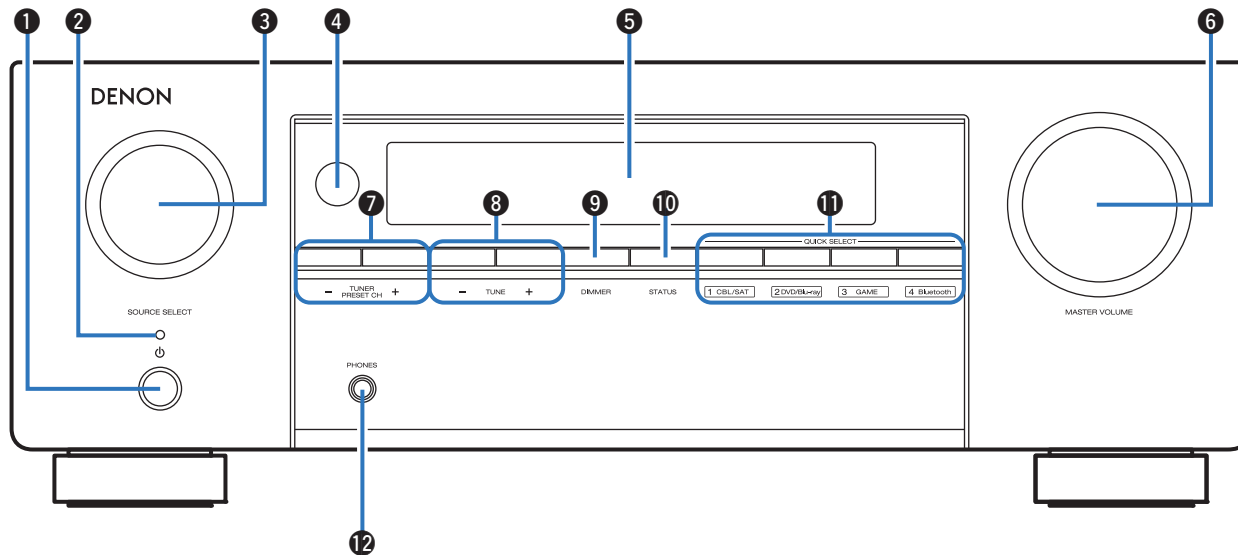

For details, see the next page.



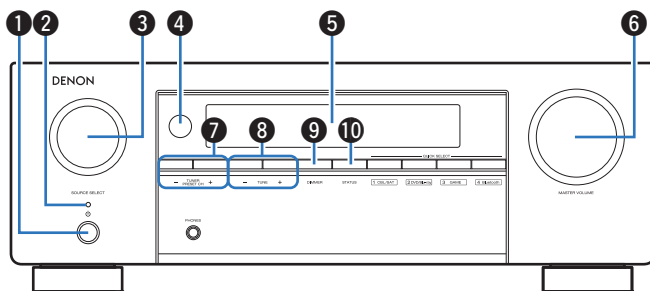

1 Power operation button (⏻)

Used to turn the power on/off (standby). (☞ p. 37)

2 Power indicator

This is lit as follows according to the power status:

- Green: Power on
- Off: Normal standby
- Red:
 - When “HDMI PassThrough” is set to “On” (☞ p. 77)
 - When “HDMI Control” is set to “On” (☞ p. 78)
 - When “BluetoothStandby” is set to “On” (☞ p. 89)

3 SOURCE SELECT knob

This selects the input source. (☞ p. 37)

4 Remote control sensor

This receives signals from the remote control unit. (☞ p. 6)

5 Display

This displays various pieces of information. (☞ p. 13)

6 MASTER VOLUME knob

This adjusts the volume level. (☞ p. 38)

7 Tuner preset channel buttons (TUNER PRESET CH +, -)

These select preset broadcast stations. (☞ p. 50)

8 Tuning buttons (TUNE +, -)

Select either FM broadcast or AM broadcast. (☞ p. 45)

9 DIMMER button

Each press of this switches the brightness of the display. (☞ p. 90)

10 STATUS button

Each press of this switches the status information that is shown on the display.



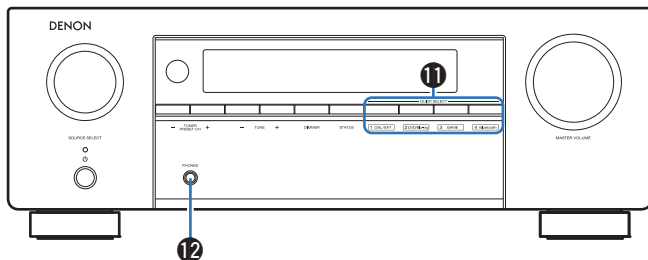

11 QUICK SELECT buttons

With a single press of any of these buttons, you can call up various settings you've registered to each button such as the input source, volume level and sound mode settings. (👉 p. 65)

12 Headphones jack (PHONES)

This is used to connect headphones.
When the headphones are plugged into this jack, audio will no longer be output from the connected speakers or from the SUBWOOFER connectors.

NOTE

- To prevent hearing loss, do not raise the volume level excessively when using headphones.



Display

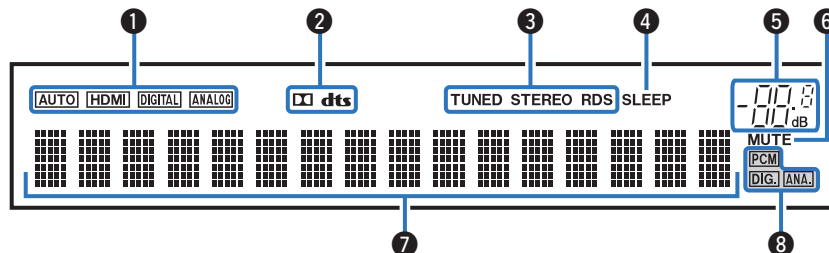

1 Input mode indicators

These light according to the audio input mode settings of each input source. (☞ p. 82)

2 Decoder indicators

These light when Dolby or DTS signals are input or when the Dolby or DTS decoder is running.

3 Tuner reception mode indicators

These light up according to the reception conditions when the input source is set to "Tuner".

TUNED: Lights up when the broadcast is properly tuned in.

STEREO: Lights up when receiving FM stereo broadcasts.

RDS : Lights up when receiving RDS broadcasts.

4 Sleep timer indicator

This lights when the sleep mode is selected. (☞ p. 63)

5 Volume indicator

6 MUTE indicator

This blinks while the sound is muted. (☞ p. 38)

7 Information display

The input source name, sound mode, setting values and other information are displayed here.

8 Input signal indicators

The respective indicator will light corresponding to the input signal. (☞ p. 82)



Rear panel

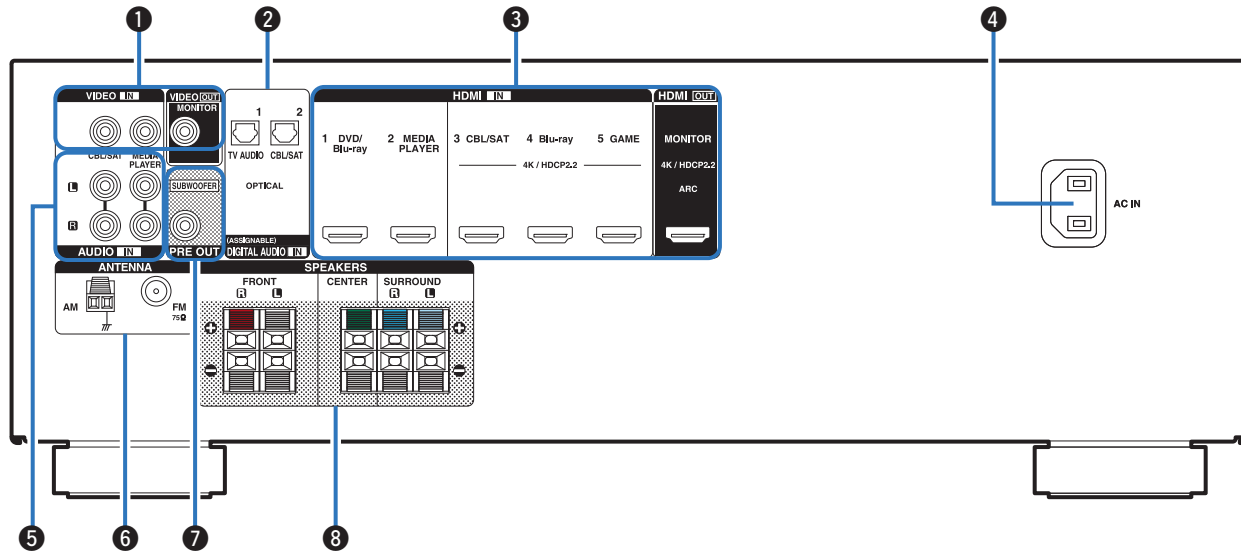

For details, see the next page.



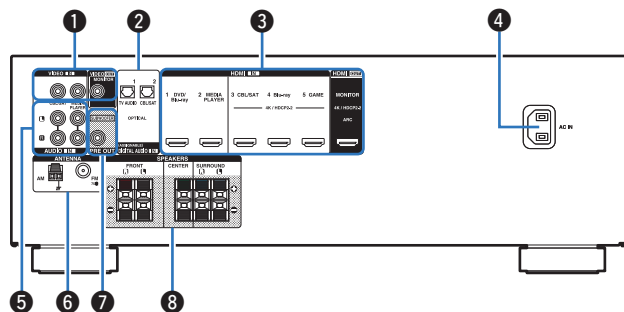

1 Video connectors (VIDEO)

Used to connect devices equipped with video connectors.

- “Connection 3 : TV equipped without an HDMI connector” (☞ p. 28)
- “Connecting a set-top box (Satellite tuner/cable TV)” (☞ p. 30)

2 Digital audio connectors (DIGITAL AUDIO)

Used to connect devices equipped with digital audio connectors.

- “Connection 2 : TV equipped with an HDMI connector and incompatible with the ARC (Audio Return Channel)” (☞ p. 27)
- “Connection 3 : TV equipped without an HDMI connector” (☞ p. 28)
- “Connecting a set-top box (Satellite tuner/cable TV)” (☞ p. 30)

3 HDMI connectors

Used to connect devices equipped with HDMI connectors.

- “Connection 1 : TV equipped with an HDMI connector and compatible with the ARC (Audio Return Channel)” (☞ p. 26)
- “Connection 2 : TV equipped with an HDMI connector and incompatible with the ARC (Audio Return Channel)” (☞ p. 27)
- “Connecting a set-top box (Satellite tuner/cable TV)” (☞ p. 30)
- “Connecting a DVD player or Blu-ray Disc player” (☞ p. 31)
- “Connecting a game console or video camcorder” (☞ p. 32)

4 AC inlet (AC IN)

Used to connect the power cord. (☞ p. 35)

5 Analog audio connectors (AUDIO)

Used to connect devices equipped with analog audio connectors. (☞ p. 30)

6 FM/AM antenna terminals (ANTENNA)

Used to connect FM antennas and AM loop antennas. (☞ p. 33)

7 PRE OUT connectors

Used to connect a subwoofer with a built-in amplifier. (☞ p. 23)

8 Speaker terminals (SPEAKERS)

Used to connect speakers. (☞ p. 22)



Remote control unit

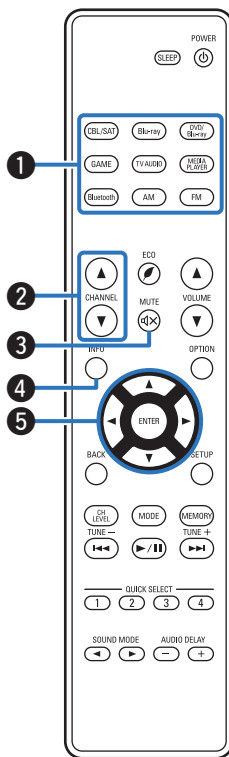

1 Input source select buttons

These select the input source. (☞ p. 37)

2 Channel buttons (CHANNEL ▲▼)

These select radio stations registered to presets. (☞ p. 50)

3 MUTE button (M)

This mutes the output audio. (☞ p. 38)

4 Information button (INFO)

This displays the status information on the TV screen. (☞ p. 92)

5 Cursor buttons (▲▼◀▶)

These select items.



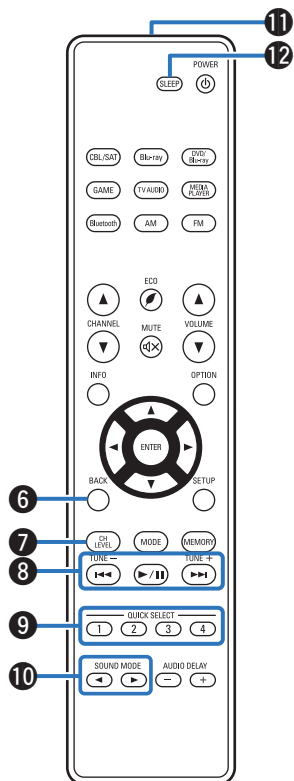

6 BACK button

This returns to the previous screen.

7 Channel level button (CH LEVEL)

Adjusting the volume of the speakers. (☞ p. 62)

8 System buttons

These perform playback related operations.

Tuning up / Tuning down buttons (TUNE +, -)

These select either FM broadcast or AM broadcast. (☞ p. 45)

9 QUICK SELECT buttons (1 - 4)

These call up settings registered to each button, such as input source, volume level and sound mode settings. (☞ p. 65)

10 SOUND MODE buttons (◀▶)

These select the sound mode. (☞ p. 57)

11 Remote control signal transmitter

This transmits signals from the remote control unit. (☞ p. 6)

12 SLEEP button

This sets the sleep timer. (☞ p. 63)



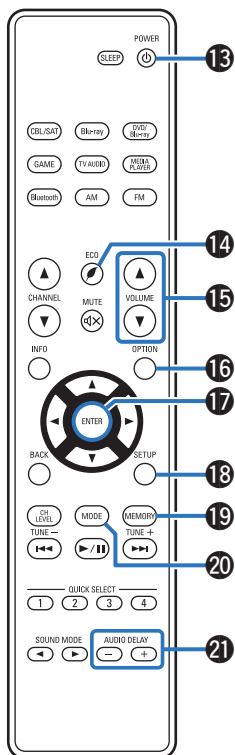

13 POWER button (⏻)

This turns the power on/off. (☞ p. 37)

14 ECO Mode button (🌿)

This switches to ECO Mode. (☞ p. 87)

15 VOLUME buttons (▲▼)

These adjust the volume level. (☞ p. 38)

16 OPTION button

This displays the option menu on the TV screen.

17 ENTER button

This determines the selection.

18 SETUP button

This displays the menu on the TV screen. (☞ p. 70)

19 Preset memory button (MEMORY)

The current broadcast station that is preset. (☞ p. 50)

20 Tuning mode select button (MODE)

This switches the tune mode. (☞ p. 45)

21 AUDIO DELAY buttons (+, -)

Compensates for incorrect timing between video and audio. (☞ p. 75)



■ Contents

Connecting speakers	20
Connecting a TV	25
Connecting a playback device	29
Connecting an FM/AM antenna	33
Connecting the power cord	35

NOTE

- Do not plug in the power cord until all connections have been completed. However, when the "Setup Assistant" is running, follow the instructions in the "Setup Assistant" (page 7 in the separate "Quick Start Guide") screen for making connections. (During "Setup Assistant" operation, the input/output connectors do not conduct current.)
- Do not bundle power cords together with connection cables. Doing so can result in noise.

■ Cables used for connections

Provide necessary cables according to the devices you want to connect.

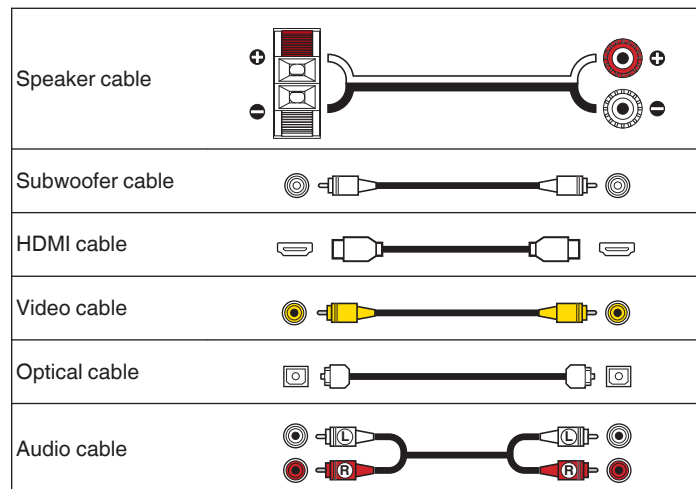

Connecting speakers

Install speakers and connect them to this unit. (“Speaker installation” (🔗 p. 20), “Speaker connection” (🔗 p. 22))

Speaker installation

Determine the speaker system depending on the number of speakers you are using and install each speaker and subwoofer in the room. Speaker installation is explained using this example of a typical installation.

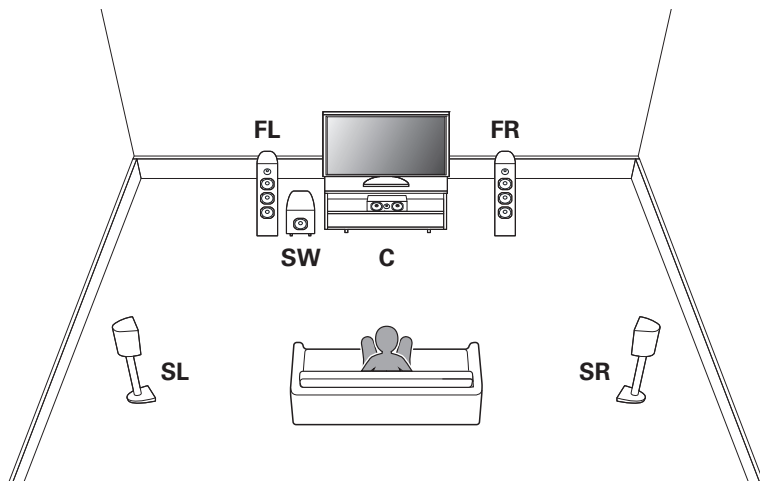

FL/FR (Front speaker left/ right):	Place the FRONT left and right speakers an equal distance from the main listening position. The distance between each speaker and your TV should also be the same.
C (Center speaker):	Place the CENTER speaker in between the front speakers and above or below your TV.
SL/SR (Surround speaker left/ right):	Place the SURROUND left and right speakers an equal distance to the left and right sides of the main listening position.
SW (Subwoofer) :	Place the SUBWOOFER at a convenient location near the front speakers.





- Use the illustration below as a guide for how high each speaker should be installed. The height does not need to be exactly the same.

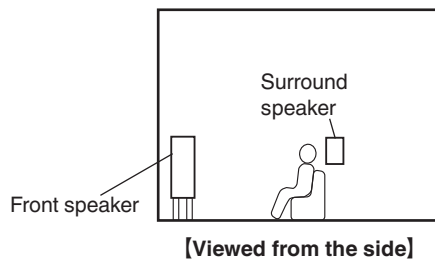

■ When 5.1-channel speakers are installed

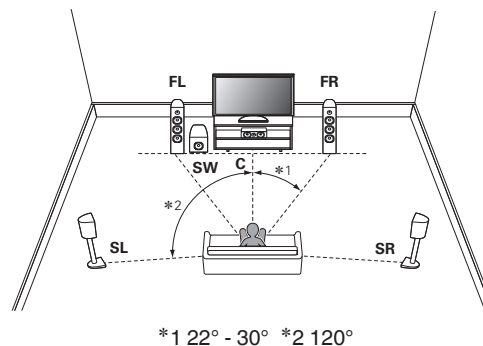

Speaker connection

Here we connect the speakers in the room to this unit.

This section explains how to connect them using typical examples.

NOTE

- Disconnect this unit's power plug from the power outlet before connecting the speakers. Also, turn off the subwoofer.
- Connect so that the speaker cable core wires do not protrude from the speaker terminal. The protection circuit may be activated if the core wires touch the rear panel or if the + and - sides touch each other. ("Protection circuit" (👉 p. 118))
- Never touch the speaker terminals while the power cord is connected. Doing so could result in electric shock. When the "Setup Assistant" (page 7 in the separate "Quick Start Guide") is running, follow the instructions in the "Setup Assistant" screen for making connections. (Power is not supplied to the speaker terminals while the "Setup Assistant" is running.)
- Use speakers with an impedance of 6 – 16 Ω/ohms.

■ Connecting the speaker cables

Carefully check the left (L) and right (R) channels and + (red) and – (black) polarities on the speakers being connected to this unit, and be sure to connect the channels and polarities correctly.

- 1 Peel off about 10 mm of sheathing from the tip of the speaker cable, then either twist the core wire tightly or terminate it.**



- 2 Press the lever on the speaker terminal.**



- 3 Holding the lever on the speaker terminal, insert the core wire of the speaker cable all the way into the speaker terminal.**



- 4 Release your finger from the lever on the speaker terminal.**



■ Connecting the subwoofer

Use a subwoofer cable to connect the subwoofer.

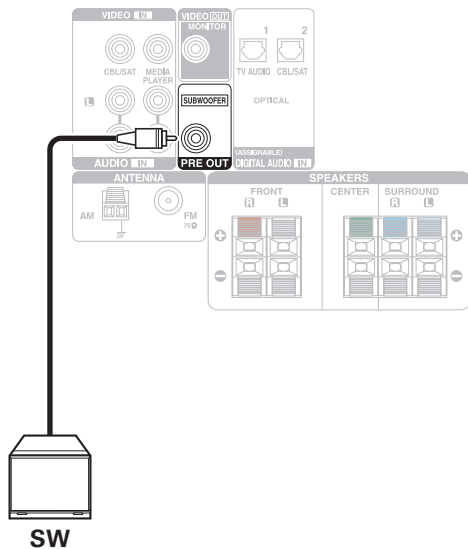

Standard speaker configuration and connection

This serves as a basic 5.1-channel surround system. Sound modes such as Dolby Pro Logic II are supported.

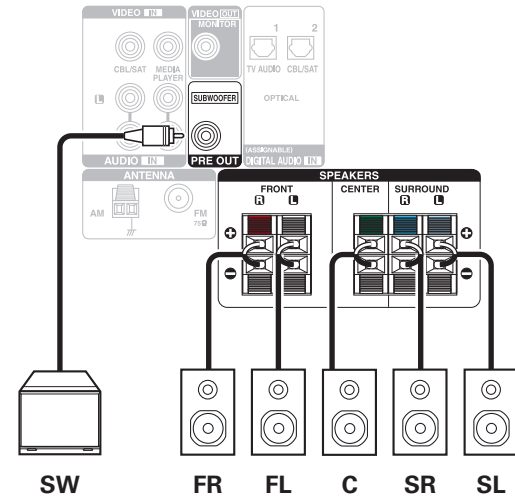
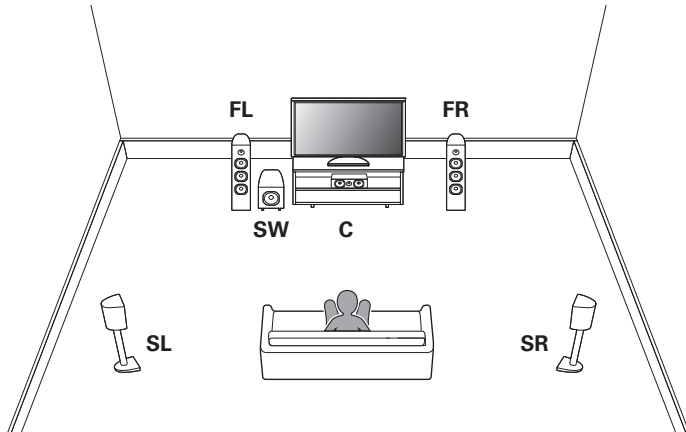

Connecting a TV

Connect a TV to this unit so that the input video is output to the TV. You can also enjoy audio from the TV on this unit.

How to connect a TV depends on the connectors and functions equipped on the TV.

ARC (Audio Return Channel) function plays TV audio on this unit by sending the TV audio signal to this unit via HDMI cable.

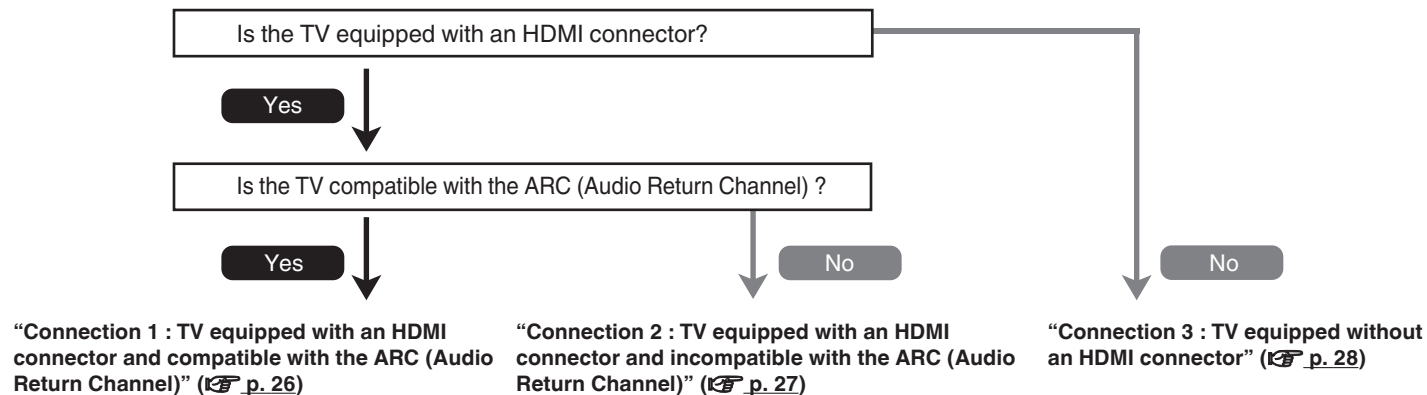

Connection 1 : TV equipped with an HDMI connector and compatible with the ARC (Audio Return Channel)

Use an HDMI cable to connect a TV that is compatible with the ARC function to this unit.
Set "HDMI Control" to "On" when using a TV that supports the ARC function. (👉 p. 78)

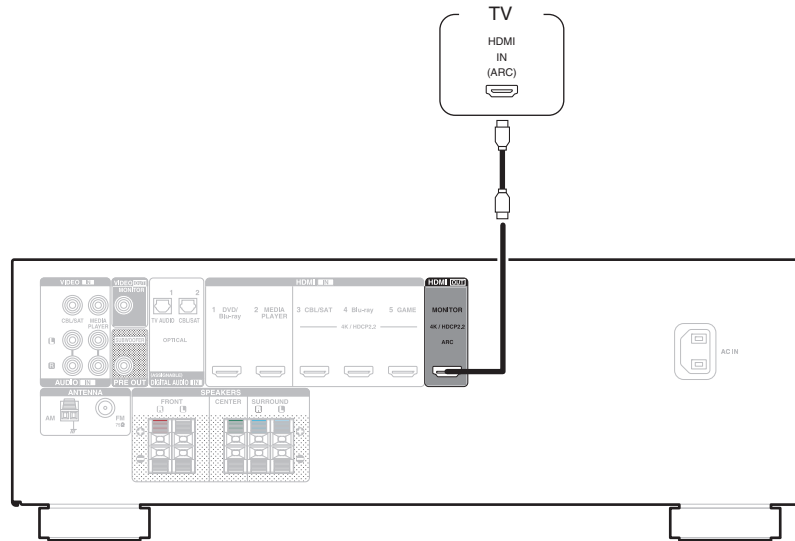

Connection 2 : TV equipped with an HDMI connector and incompatible with the ARC (Audio Return Channel)

Use an HDMI cable to connect the TV to this unit.

To listen to audio from TV on this unit, use an optical cable to connect the TV to this unit.

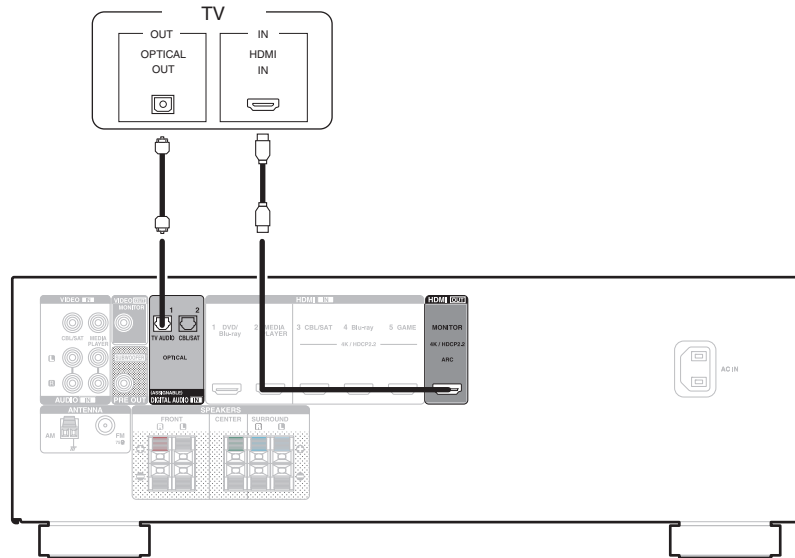

Connection 3 : TV equipped without an HDMI connector

Use a video cable to connect the TV to this unit.

To listen to audio from TV on this unit, use an optical cable to connect the TV to this unit.

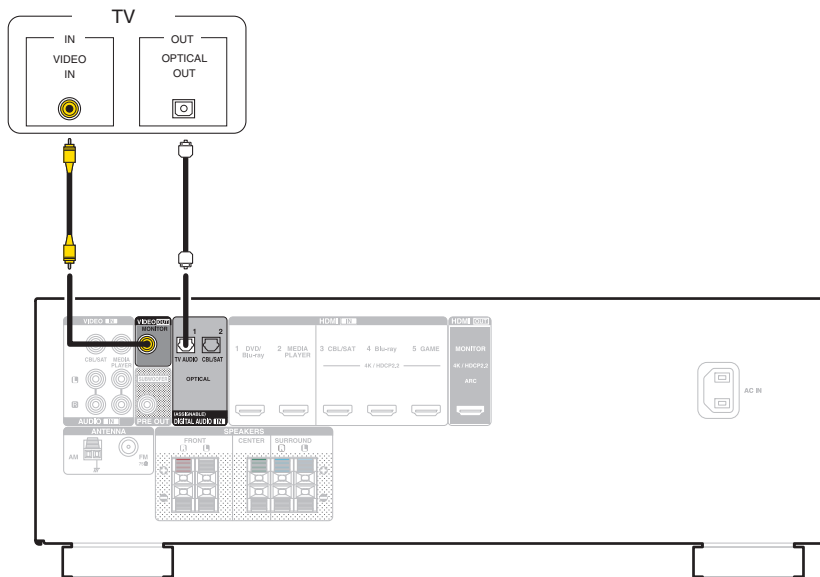

Connecting a playback device

This unit is equipped with two types of video input connectors (HDMI and composite video) and three types of audio input connectors (HDMI, digital audio and audio).

Select input connectors on this unit according to the connectors equipped on the device you want to connect.

If the device connected to this unit is equipped with an HDMI connector, it is recommended to use HDMI connections.

In the HDMI connection, audio and video signals can be transmitted through a single HDMI cable.

- “Connecting a set-top box (Satellite tuner/cable TV)” (🔗 p. 30)
- “Connecting a DVD player or Blu-ray Disc player” (🔗 p. 31)
- “Connecting a game console or video camcorder” (🔗 p. 32)



- Connect devices to this unit as indicated by the input sources printed on the audio/video input connectors of this unit.
- The source that is assigned to the OPTICAL 1 and OPTICAL 2 connectors can be changed. See “Input Assign” on how to change the input source assigned to the input connectors. (🔗 p. 81)
- To play back audio signals that are input to this unit on a TV connected via HDMI, set “HDMI Audio Out” to “TV”. (🔗 p. 77)
- To enjoy content that is copyright protected by HDCP 2.2, use a playback device and TV compatible with HDCP 2.2 only.
- To enjoy 4K content or content that is copyright protected by HDCP 2.2, connect the device to the HDMI 3, HDMI 4 or HDMI 5 input connector.



Connecting a set-top box (Satellite tuner/cable TV)

This explanation uses the connection with a satellite tuner/cable TV STB as an example.

Select the input connectors on this unit to match the connectors on the device that you want to connect to.

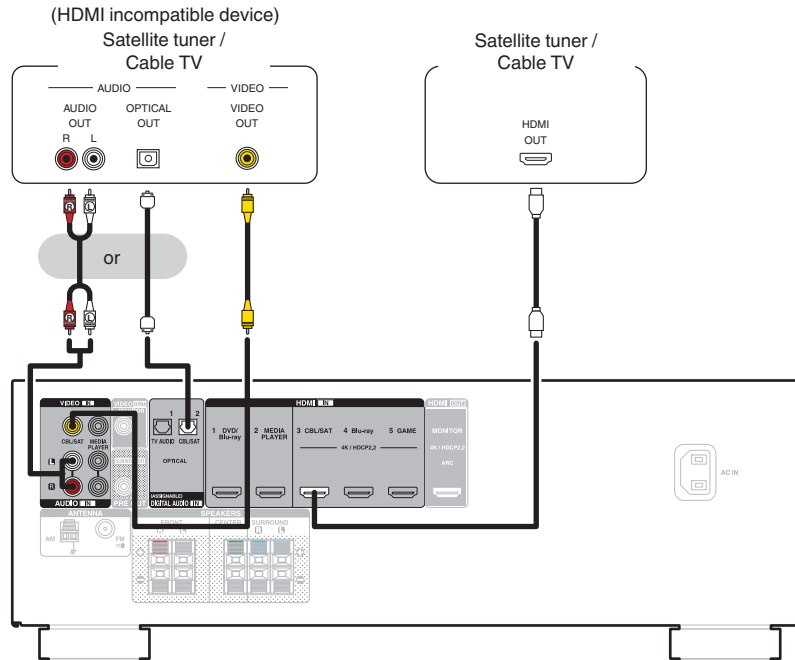

Connecting a DVD player or Blu-ray Disc player

This explanation uses the connection with a DVD player or Blu-ray Disc player as an example.

When connecting a 4K / HDCP 2.2 compatible player, connect to either the HDMI 3, HDMI 4 or HDMI 5 input connector.

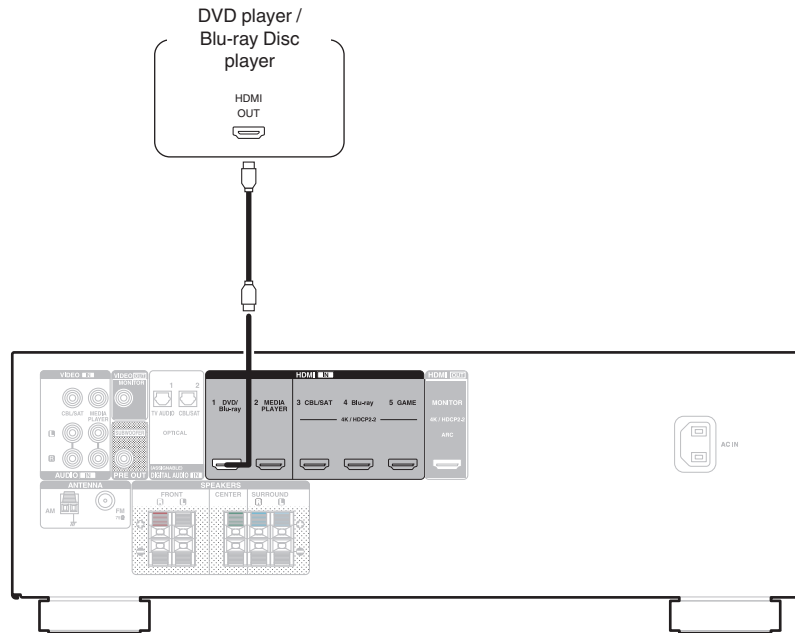

Connecting a game console or video camcorder

This explanation uses the connection with a game console as an example.

Connect a playback device to this unit, such as a game console or video camcorder.

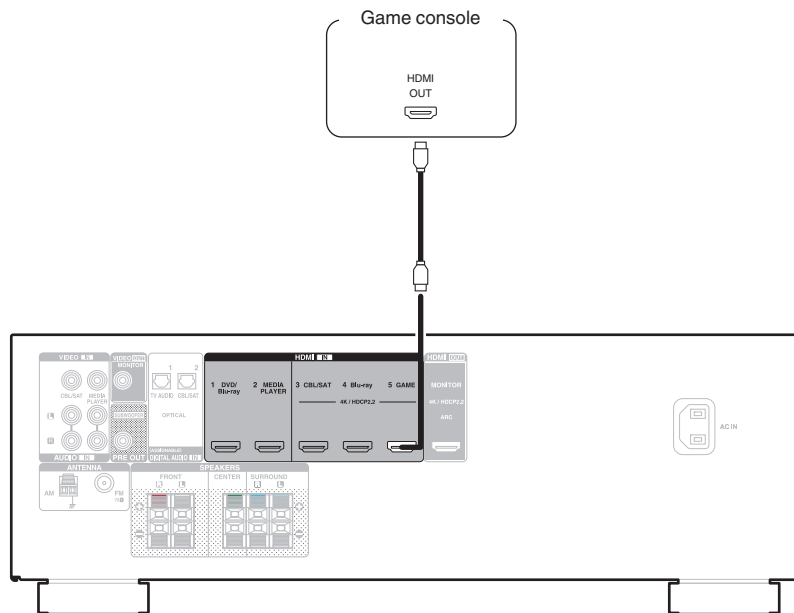

Connecting an FM/AM antenna

Connect the antenna, tune in to a broadcast and then move the antenna to the location where there is least noise. Then use tape, etc. to fix the antenna in this location. (“Listening to FM/AM broadcasts” (p. 44))



- If you are unable to receive a good broadcast signal, we recommend installing an outdoor antenna. For details, inquire at the retail store where you purchased the unit.

NOTE

- Make sure the AM loop antenna lead terminals do not touch metal parts of the panel.

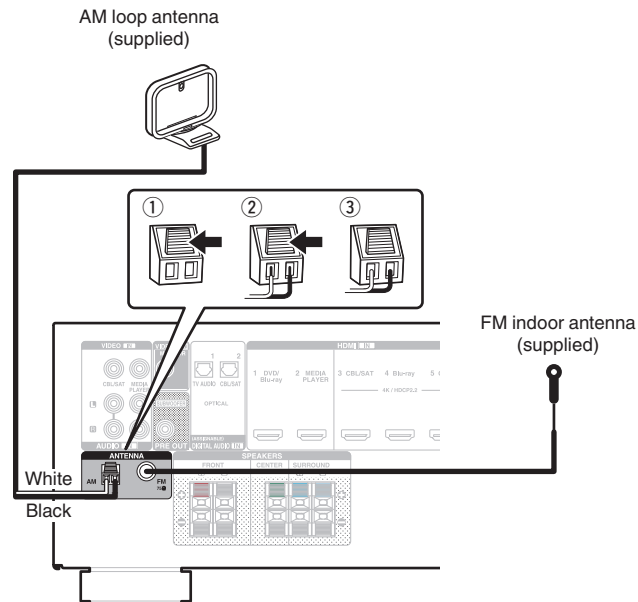

■ Using the AM loop antenna

Suspending on a wall

Suspend directly on a wall without assembling.

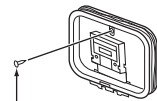

Nail, tack, etc.

Standing alone

Use the procedure shown above to assemble.

When assembling, refer to “AM loop antenna assembly”.

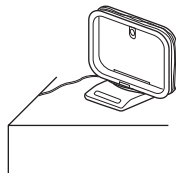

■ AM loop antenna assembly

- 1 Put the stand section through the bottom of the loop antenna from the rear and bend it forward.
- 2 Insert the projecting part into the square hole in the stand.

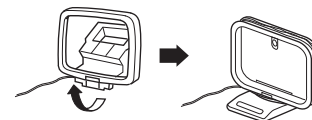
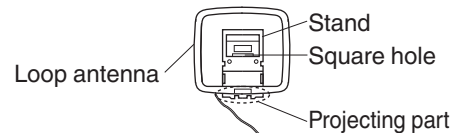

Connecting the power cord

After completing all the connections, insert the power plug into the power outlet.

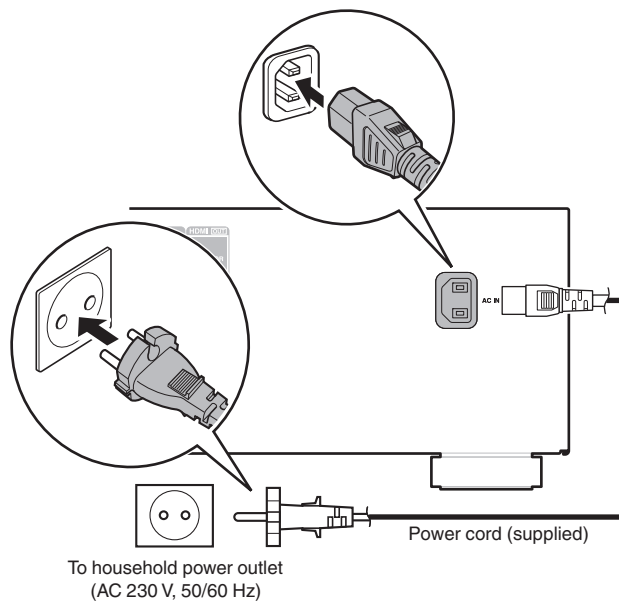

■ Contents

Basic operation

Turning the power on	37
Selecting the input source	37
Adjusting the volume	38
Turning off the sound temporarily (Muting)	38
Selecting a sound mode	57

Playback a device

Playing a DVD player/Blu-ray Disc player	38
Listening to music on a Bluetooth device	39
Listening to FM/AM broadcasts	44

Convenience functions

Convenience functions	52
HDMI control function	61
Adjusting the volume of each channel to match the input source (Ch Level Adjust)	62
Sleep timer function	63
Quick select plus function	65



Basic operation

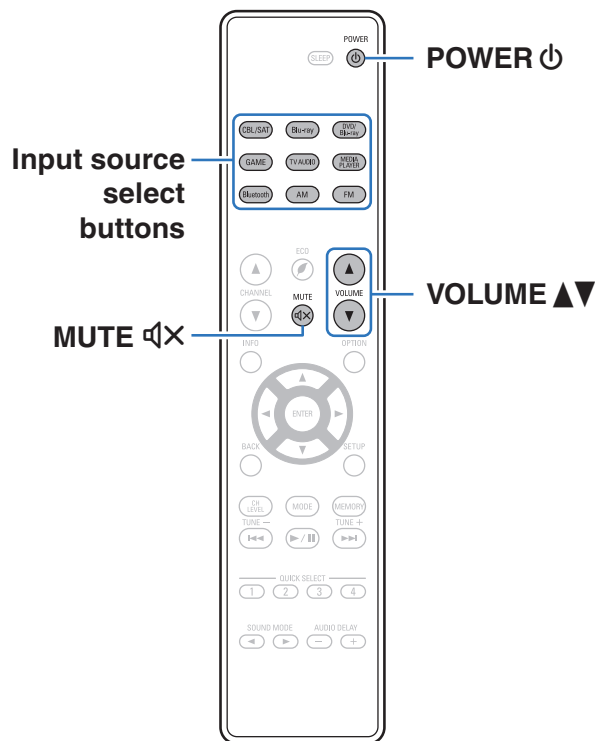

Turning the power on

1 Press **POWER** \odot to turn on power to the unit.



- You can press the input source select button when the unit is in standby mode to turn on the power.
- You can also switch the power to standby by pressing \odot on the main unit.

Selecting the input source

1 Press the **input source select** button to be played back.
The desired input source can be selected directly.



- You can also select the input source by turning **SOURCE SELECT** on the main unit.



Adjusting the volume

1 Use VOLUME ▲▼ to adjust the volume.





- The variable range differs according to the input signal and channel level setting.
- You can also adjust the master volume by turning MASTER VOLUME on the main unit.

Turning off the sound temporarily (Muting)

1 Press MUTE .

- MUTE indicator on the display flashes.
-  appears on the TV screen.



- The sound is reduced to the level set at “Mute Level” in the menu. ( p. 76)
- To cancel mute, either adjust the sound volume or press MUTE  again.

Playback a DVD player/Blu-ray Disc player

The following describes the procedure for playing DVD player/Blu-ray Disc player.

1 Prepare for playback.

- ① Turn on the power of the TV, subwoofer and player.
- ② Change the TV input to the input of this unit.

2 Press POWER to turn on power to the unit.

3 Press DVD/Blu-ray (4K not supported) or Blu-ray (4K supported) to switch the input source of the player to be played back.

4 Play the DVD player or Blu-ray Disc player.

■ Surround playback (p. 57)



Listening to music on a Bluetooth device

Music files stored on Bluetooth devices such as smartphones, digital music players, etc. can be enjoyed on this unit by pairing and connecting this unit with the Bluetooth device.

Communication is possible up to a range of about 10 m.

NOTE

- To play back music from a Bluetooth device, the Bluetooth device needs to support the A2DP profile.

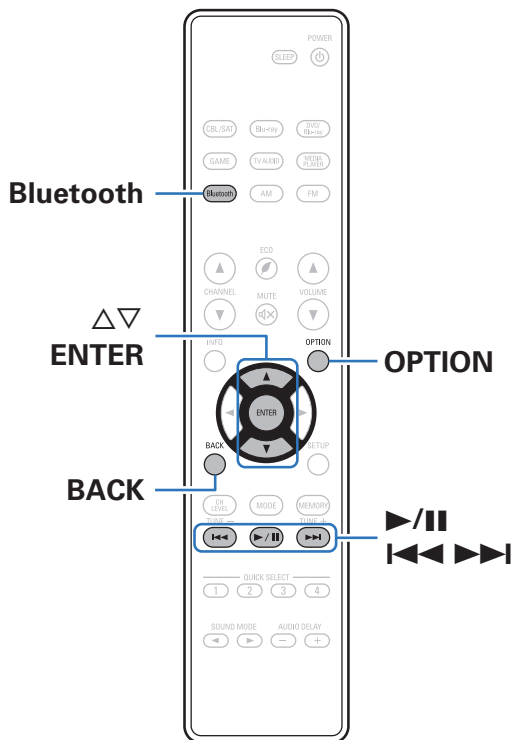

Playing music from Bluetooth device

In order to enjoy music from a Bluetooth device on this unit, the Bluetooth device must first be paired with this unit.

Once the Bluetooth device has been paired, it does not need to be paired again.

1 Press Bluetooth to switch the input source to “Bluetooth”.

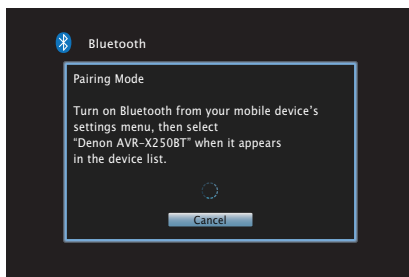

When using for the first time, the unit will go into the pairing mode automatically and “Pairing...” will appear on the display of the unit.

2 Activate the Bluetooth settings on your mobile device.

3 Select this unit when its name appears in the list of devices displayed on the screen of the Bluetooth device.

Connect to the Bluetooth device while “Pairing” is being displayed on the display of the unit.

Perform the connection with the Bluetooth device close to the unit (about 1 m).



4 Play music using any app on your Bluetooth device.

- The Bluetooth device can also be operated with the remote control of this unit.
- The next time the input source is switched to Bluetooth, this unit automatically connects to the last Bluetooth device that was connected.



- Enter “0000” when the password is requested on the screen of the Bluetooth device.



Operation buttons	Function
	Playback / Pause
	Skip to previous track / Skip to next track (Press and hold) Fast-reverse / Fast-forward
ENTER	Playback / Pause (Press and hold) Stop
	Skip to previous track / Skip to next track (Press and hold) Fast-reverse / Fast-forward







- English letters, numbers and certain symbols are displayed. Incompatible characters are displayed as “.” (period).

NOTE

- To operate the Bluetooth device with the remote control of this unit, the Bluetooth device needs to support the AVRCP profile.
- The remote control of this unit is not guaranteed to work with all Bluetooth devices.
- Depending on the type of Bluetooth device, this unit outputs audio that is coupled to the volume setting on the Bluetooth device.

■ Operations accessible through the option menu

- “Pairing with other Bluetooth devices” ( p. 42)
- “Performing repeat playback (Repeat)” ( p. 53)
- “Performing random playback (Random)” ( p. 53)
- “Adjusting the tone (Tone)” ( p. 54)
- “Displaying your desired video during audio playback (Video Select)” ( p. 56)



Pairing with other Bluetooth devices

Pair a Bluetooth device with this unit.

1 Activate the Bluetooth settings on your mobile device.

2 Press **OPTION** when the input source is “Bluetooth”.

The option menu screen is displayed.

3 Use Δ / ∇ to select “Pairing Mode”, then press **ENTER**.

The device will go into the pairing mode.

4 Select this unit when its name appears in the list of devices displayed on the screen of the Bluetooth device.



- This unit can be paired with a maximum of 8 Bluetooth devices. When a 9th Bluetooth device is paired, it will be registered in place of the oldest registered device.
- Enter “0000” when the password is requested on the screen of the Bluetooth device.
- Press and hold the Bluetooth on the remote control for at least 3 seconds to go into pairing mode.



Reconnecting to this unit from a Bluetooth device

After pairing is completed, the Bluetooth device can be connected without performing any operations on this unit.

This operation also needs to be performed when switching the Bluetooth device for playback.

- 1 If a Bluetooth device is currently connected, deactivate the Bluetooth setting of that device to disconnect it.**
- 2 Activate the Bluetooth setting of the Bluetooth device to be connected.**
- 3 Select this unit from the Bluetooth device list on your Bluetooth device.**
- 4 Play music using any app on your Bluetooth device.**



- When the power of this unit is turned on, the input source will be automatically switched to “Bluetooth” if a Bluetooth device is connected.
- When the “BluetoothStandby” setting of this unit is set to “On”, “Auto-Select” setting of this unit is set to “On”, and a Bluetooth device is connected with the unit in the standby state, the power of the unit will be turned on automatically.

( p. 89)



Listening to FM/AM broadcasts

You can use the built-in tuner of this unit to listen to FM broadcasts and AM broadcasts.

Make sure the FM antenna and AM loop antenna are connected to this unit first.

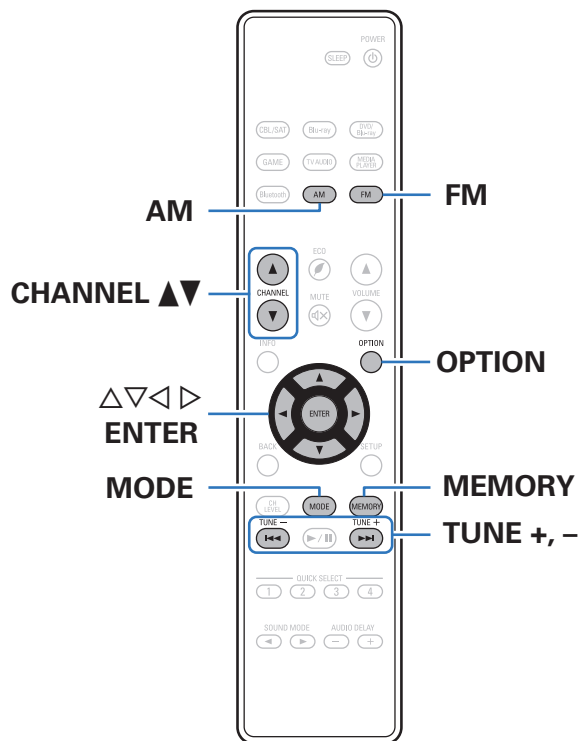

Listening to FM/AM broadcasts

- 1 Connect the antenna. (“Connecting an FM/AM antenna” (🔗 p. 33))
- 2 Press FM or AM to switch the input source to “FM” or “AM”.

[TV screen]



[Display of this unit]

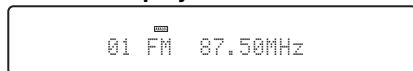

- 3 Press MODE to select the tune mode.

AUTO (Default) :	Automatically search for and tune to a receivable radio station.
----------------------------	--

MANUAL:	Manually change the frequency one step at a time each time the button is pressed.
----------------	---

- 4 Press TUNE + or TUNE - to select the station you want listen to.

Scanning is performed until it finds an available radio station. When it finds a radio station, it stops the scan automatically and tunes in.



- In “AUTO” mode, you cannot tune in to radio stations if the reception is not good. If this is the case, then use the “MANUAL” mode to tune in.
- You can also scan the broadcast station by pressing TUNE + or TUNE - on the unit.

Operation buttons	Function
CHANNEL ▲▼	Selects preset radio stations
MODE	Switching tune mode
MEMORY	Register presets
TUNE +, -	Selects the radio station (up/down)



■ Operations accessible through the option menu

- “RDS search” (🔍 p. 46)
- “PTY search” (🔍 p. 47)
- “TP search” (🔍 p. 48)
- “Radio Text” (🔍 p. 48)
- “Tuning in to stations and presetting them automatically (Auto Preset)” (🔍 p. 49)
- “Skipping preset broadcast stations (Preset Skip)” (🔍 p. 51)
- “Adjusting the tone (Tone)” (🔍 p. 54)
- “Displaying your desired video during audio playback (Video Select)” (🔍 p. 56)

RDS search

RDS (works only on the FM band) is a broadcasting service which allows a station to send additional information along with the regular radio program signal.

Use this function to automatically tune to FM stations that provide the RDS service.

Note that the RDS function only works when receiving RDS compatible stations.

- 1 Press OPTION when the input source is “FM”.**
The option menu screen is displayed.
- 2 Use $\Delta\nabla$ to select “RDS Search”, then press ENTER.**
- 3 Press ENTER.**
The search for RDS stations begins automatically.



PTY search

Use this function to find RDS stations broadcasting a designated program type (PTY).

PTY identifies the type of RDS program.

The program types and their displays are as follows:

NEWS	News	WEATHER	Weather
AFFAIRS	Current Affairs	FINANCE	Finance
INFO	Information	CHILDREN	Children's program
SPORT	Sports	SOCIAL	Social Affairs
EDUCATE	Education	RELIGION	Religion
DRAMA	Drama	PHONE IN	Phone In
CULTURE	Culture	TRAVEL	Travel
SCIENCE	Science	LEISURE	Leisure
VARIED	Varied	JAZZ	Jazz Music
POP M	Pop Music	COUNTRY	Country Music
ROCK M	Rock Music	NATION M	National Music
EASY M	Easy Listening Music	OLDIES	Oldies Music
LIGHT M	Light Classical	FOLK M	Folk Music
CLASSICS	Serious Classical	DOCUMENT	Documentary
OTHER M	Other Music		

- 1 Press OPTION when the input source is “FM”.**
The option menu screen is displayed.
- 2 Use $\Delta\nabla$ to select “PTY Search”, then press ENTER.**
- 3 Use $\Delta\nabla$ to call out the desired program type.**
- 4 Press ENTER.**
PTY search begins automatically.



TP search

TP identifies programs that carry traffic announcements.

This allows you to easily find out the latest traffic conditions in your area before leaving home.

Use this function to find RDS stations broadcasting traffic programs (TP stations).

- 1 Press OPTION when the input source is “FM”.**
The option menu screen is displayed.
- 2 Use $\Delta\nabla$ to select “TP Search”, then press ENTER.**
- 3 Press ENTER.**
TP search begins automatically.

Radio Text

RT allows RDS stations to send text messages that appear on the display. “Radio text” appears on the display when radio text data is received.

- 1 Press OPTION when the input source is “FM”.**
The option menu screen is displayed.
- 2 Use $\Delta\nabla$ to select “Radio Text”, then press ENTER.**
- 3 Use $\triangleleft\rangle$ to select “On”, then press ENTER.**
 - While receiving an RDS broadcast station, the text data broadcast from the station is displayed.
 - If no text data is being broadcast, “NO TEXT DATA” is displayed.



Tuning in to stations and presetting them automatically (Auto Preset)

A maximum of 56 radio stations can be automatically preset.

1 Press **OPTION** when the input source is “FM”.

The option menu screen is displayed.

2 Use **Δ∇** to select “Auto Preset”, then press **ENTER**.

The unit starts to tune in to radio stations automatically and preset them.

- When presetting is completed, “Completed” is displayed for about 5 seconds and the option menu screen turns off.



- The preset memory is overwritten.



Presetting the current broadcast station (Preset Memory)

Your favorite broadcast stations can be preset so that you can tune them in easily.

Up to 56 stations can be preset.

- 1** Tune in the broadcast station you want to preset. (“Listening to FM/AM broadcasts” (🔗 p. 45))
- 2** Press MEMORY.
- 3** Use Δ / ∇ to select the channel you want to preset.
- 4** Press MEMORY.

The current broadcast station that is preset.

- To preset other stations, repeat steps 1 to 4.

Channel	Default settings
1 – 8	87.50 / 89.10 / 98.10 / 108.00 / 90.10 / 90.10 / 90.10 / 90.10 MHz
9 – 16	522 / 603 / 999 / 1404 / 1611 kHz, 90.10 / 90.10 / 90.10 MHz
17 – 24	90.10 / 90.10 / 90.10 / 90.10 / 90.10 / 90.10 / 90.10 / 90.10 MHz
25 – 32	90.10 / 90.10 / 90.10 / 90.10 / 90.10 / 90.10 / 90.10 / 90.10 MHz
33 – 40	90.10 / 90.10 / 90.10 / 90.10 / 90.10 / 90.10 / 90.10 / 90.10 MHz
41 – 48	90.10 / 90.10 / 90.10 / 90.10 / 90.10 / 90.10 / 90.10 / 90.10 MHz
49 – 56	90.10 / 90.10 / 90.10 / 90.10 / 90.10 / 90.10 / 90.10 / 90.10 MHz

Listening to preset stations

- 1** Use CHANNEL \blacktriangle / \blacktriangledown to select the desired preset channel.



- You can also select preset broadcast stations by pressing TUNER PRESET CH + or TUNER PRESET CH - on the main unit.



Skipping preset broadcast stations (Preset Skip)

Perform auto preset memory to save all the broadcasting stations that can be received in the memory. Selecting a broadcast station becomes easier by skipping unnecessary memories.

1 Press **OPTION** when the input source is “FM” or “AM”.

The option menu screen is displayed.

2 Use $\Delta\nabla$ to select “Preset Skip”, then press **ENTER**.

The “Preset Skip” screen is displayed.

3 Use $\Delta\nabla$ to select the group of broadcast stations you want to skip.

Skip all the broadcast stations that are included in the selected group “Preset *-*”.

(* is the selected group number.)

4 Use $\triangleleft\rangle$ to select “Skip”.

The station you selected is not displayed.

Cancelling Preset Skip

1 While the “Preset Skip” screen is displayed, use $\Delta\nabla$ to select a group of a broadcast stations to cancel the skip for.

2 Use $\triangleleft\rangle$ to select “On”.

The skip is cancelled.



Convenience functions

This section explains how to use convenient functions that can be used for each input source.

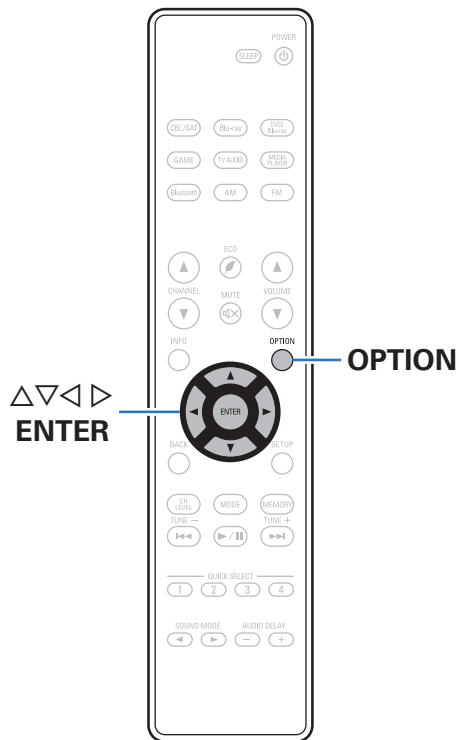

Performing repeat playback (Repeat)

❑ Supported input sources : Bluetooth

1 While content is playing, press OPTION.

The option menu screen is displayed.

2 Use $\Delta \nabla$ to select “Repeat”, then press ENTER.

3 Use $\triangleleft \triangleright$ to select repeat playback mode.

Off (Default):	Repeat playback mode is canceled.
One:	A file being played is played repeatedly.
All:	All files in the folder currently being played are played repeatedly.

4 Press ENTER.

The display returns to the playback screen.

Performing random playback (Random)

❑ Supported input sources : Bluetooth

1 While content is playing, press OPTION.

The option menu screen is displayed.

2 Use $\Delta \nabla$ to select “Random”, then press ENTER.

3 Use $\triangleleft \triangleright$ to select random playback mode.

Off (Default):	Disable random playback.
On:	Randomly play back all tracks in the current playback folder.

4 Press ENTER.

The display returns to the playback screen.



- During random playback, each time playback of a track is completed, another track is randomly selected for playback from tracks in the folder. Therefore, it's possible that you may hear a track played back more than once during random playback.



Adjusting the tone (Tone)

Adjusts the tonal quality of the sound.

- 1 Press OPTION.**
The option menu screen is displayed.
- 2 Use $\Delta \nabla$ to select "Tone", then press ENTER.**
The "Tone" screen is displayed.
- 3 Use $\triangleleft \triangleright$ to set the tone control function to on/off.**

On:	Allow tone adjustment (bass, treble).
------------	---------------------------------------

Off (Default):	Playback without tone adjustment.
--------------------------	-----------------------------------

- 4 Select "On" in step 3 and press ∇ to select the sound range to be adjusted.**

Bass:	Adjust bass.
--------------	--------------

Treble:	Adjust treble.
----------------	----------------

- 5 Use $\triangleleft \triangleright$ to adjust the tone, then press ENTER.**

-6 dB – +6 dB (Default : 0 dB)



- "Tone" settings are stored for each input source.
- This cannot be set when the sound mode is set to "Direct".
- You cannot set this when no audio signal is input or in the menu "HDMI Audio Out" is set to "TV". (p. 77)



Optimizing the night time listening volume (Night Mode)

Compress dynamic range (difference between loud and soft sounds). This can be set when a Dolby Digital signal is input.

1 Press **OPTION**.

The option menu screen is displayed.

2 Use **Δ∇** to select “Night Mode”, then press **ENTER**.

The Night Mode setting screen is displayed.

3 Use **<|>** to select “Night Mode”, then press **ENTER**.

Low :	Set the adjusted value to low.
Medium :	Set the adjusted value to middle.
High :	Set the adjusted value to high.
Auto :	Automatic dynamic range compression on/off control according to the source.
Off (Default):	Do not set.



- “Auto” can be set when a Dolby TrueHD signal is input.
- The default setting is “Off”. The default setting when the input signal is Dolby TrueHD is “Auto”.



Displaying your desired video during audio playback (Video Select)

This unit can display video from a different source on TV during audio playback. You can set this for each input source.

Supported input sources : FM / AM / Bluetooth

1 Press **OPTION** during audio playback.

The option menu screen is displayed.

2 Use **△▽** to select “Video Select”, then press **ENTER**.

3 Use **◀▶** to select the Video Select mode.

Off
(Default): Disable Video Select mode.

On: Enable Video Select mode.

4 Use **◀▶** to select the input source for video you want to play back, then press **ENTER**.



- “Video Select” settings are stored for each input source.



Selecting a sound mode



SOUND MODE



This unit allows you to enjoy various kinds of surround and stereo playback modes.

Multi-channel audio formats are provided on popular movie and music disc formats such as Blu-ray and DVD, as well as being supported by digital broadcasting, and even by streaming movies.

This unit supports playback of almost all of these multi-channel audio formats. It also supports surround playback of audio formats other than multi-channel audio such as 2-channel stereo audio.



- For audio formats recorded on a disc, see the disc jacket or label.

Selecting a sound mode

1 Press **SOUND MODE** ◀▶ to select a sound mode.



- If the content played back does not support the previously selected sound mode, the most appropriate sound mode for the content is automatically selected.



■ Description of sound mode types

Dolby sound mode

Sound mode type	Description
Dolby PLII	This mode can be selected when the Dolby PLII decoder is used to play back 2-channel sources in 5.1-channel surround sound with an enveloping surround sound experience.
Dolby Digital	This mode can be selected when playing sources recorded in Dolby Digital.
Dolby TrueHD	This mode can be selected when playing sources recorded in Dolby TrueHD.
Dolby Digital Plus	This mode can be selected when playing sources recorded in Dolby Digital Plus.

DTS sound mode

Sound mode type	Description
DTS Neo:6	This mode can be selected when a DTS Neo:6 decoder is used to play back 2-channel source in 5.1-channel surround sound.
DTS Surround	This mode can be selected when playing sources recorded in DTS.
DTS 96/24	This mode can be selected when playing sources recorded in DTS 96/24.
DTS-HD	This mode can be selected when playing sources recorded in DTS-HD.
DTS Express	This mode can be selected when playing sources recorded in DTS Express.

PCM multi-channel sound mode

Sound mode type	Description
Multi Ch In	This mode can be selected when playing multi-channel PCM sources.



Original sound mode

Sound mode type	Description
Multi Ch Stereo	This mode is for enjoying stereo sound from all speakers.
Virtual	This mode lets you experience an expansive surround sound effect when playing back through just the front (L/R) speakers only, and when listening with stereo headphones.

Stereo sound mode

Sound mode type	Description
Stereo	<p>This mode plays 2-channel stereo audio with no additional surround sound processing.</p> <ul style="list-style-type: none"> • Sound is output from the front left and right speakers, and subwoofer if connected. • When multi-channel signals are inputted, they are mixed down to 2-channel audio and are played back with no additional surround sound processing.

Direct sound mode

Sound mode type	Description
Direct	This mode plays back audio as recorded in the source.



■ Views on the display

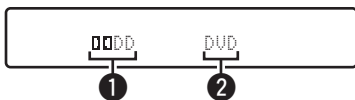

① Shows a decoder to be used.

- In the case of the Dolby Digital decoder, "Dolby Digital" is displayed.
- In the case of the Dolby Digital Plus decoder, "Dolby Digital Plus" is displayed.

② Shows the name of the input source being played back.



HDMI control function

A recent addition to the HDMI standard is CEC (Consumer Electronics Control), which allows control signals from one device to communicate with another device via the HDMI cable connection.

Setting procedure

1 Enable the HDMI control function of this unit.

Set "HDMI Control" to "On". (☞ p. 78)

2 Turn the power on for all the devices connected by HDMI cable.

3 Set the HDMI control function for all devices connected by HDMI cable.

- Please consult the operating instructions for the connected devices to check the settings.
- Carry out steps 2 and 3 should any of the devices be unplugged.

4 Switch the television input to the HDMI input connected to this unit.

5 Switch the input source of this unit to check that video from the player connected by HDMI is played back correctly.

6 When you turn the TV's power to standby, check that the power of this unit also goes to standby.

NOTE

- Some functions may not operate depending on the connected TV or player. Check the owner's manual of each device for details beforehand.



Adjusting the volume of each channel to match the input source (Ch Level Adjust)

The volume of each channel can be changed while listening to music. You can set this for each input source.

1 Press CH LEVEL.

The “Ch Level Adjust” screen is displayed.

2 Use Δ / ∇ to select the channel that you wish to adjust.

3 Use \triangleleft / \triangleright to adjust the volume.

-12.0 dB – +12.0 dB (Default : 0.0 dB)



- Select “Reset” and press ENTER if you want to restore the adjustment values of the various channels to “0.0 dB” (default).
- Headphone volume can be adjusted when a headphone is connected.
- “Ch Level Adjust” settings are stored for each input source.
- You can only set this for speakers that output audio. In addition, you cannot set this when in the menu “HDMI Audio Out” is set to “TV”. (🔗 p. 77)

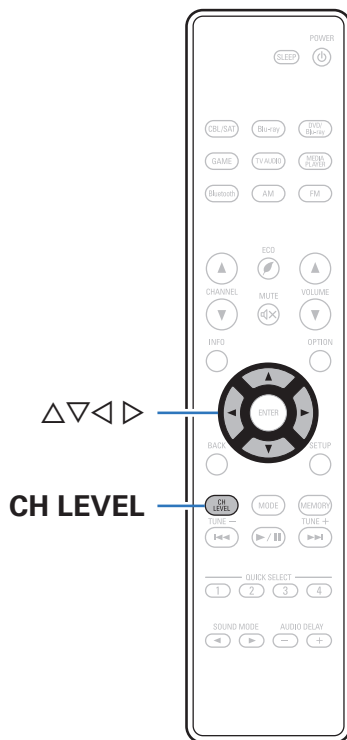

Sleep timer function

You can have the power automatically switched to standby once a set time has elapsed. This is convenient for viewing and listening while going to sleep.

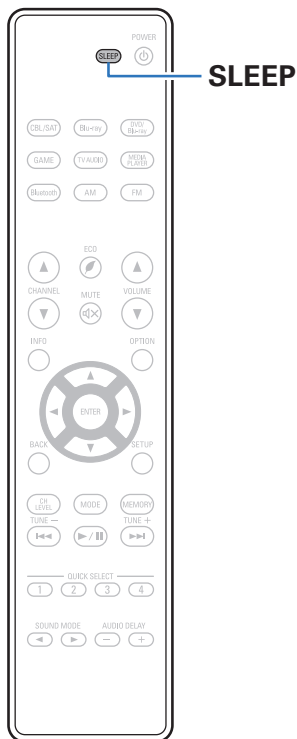

Using the sleep timer

- 1 Press SLEEP and display the time you want to set.**
 - The SLEEP indicator lights up on the display and the sleep timer starts.
 - You can set the sleep timer in the range from 10 to 120 minutes in steps of 10 minutes.

■ Checking the remaining time

Press SLEEP when the sleep timer is in operation.
The remaining time appears on the display.

■ To cancel the sleep timer

Press SLEEP to select “Off”.
The SLEEP indicator on the display turns off.



- The sleep timer setting is canceled when the unit switches to standby mode.

NOTE

- The sleep timer function cannot turn off the power of devices connected to this unit. To turn off the power of those connected devices, set up sleep timers on the connected devices themselves.



Quick select plus function



**QUICK
SELECT
1 - 4**

Settings such as the input source, volume level and sound mode can be registered to the QUICK SELECT 1 - 4 buttons.

You can simply press one of the registered QUICK SELECT buttons in subsequent playbacks to switch to the group of saved settings in a batch. By saving frequently used settings at the QUICK SELECT 1 - 4 buttons, you will always be able to easily call up the same playback environment.



Calling up the settings

1 Press QUICK SELECT.

The Quick Select settings registered to the button you pressed are called up.

- The default settings for the input source are as shown below.

Button	Input source
QUICK SELECT 1	CBL/SAT
QUICK SELECT 2	DVD/Blu-ray
QUICK SELECT 3	Game
QUICK SELECT 4	Bluetooth



- Volume is not registered to Quick Select Plus in the factory default settings. See “Changing the settings” to register volume to Quick Select Plus. (☞ p. 66)

Changing the settings

1 Set the items below to the settings you want to register.

- Input source (☞ p. 37)
- Volume (☞ p. 38)
- Video Select settings (☞ p. 56)
- Sound mode (☞ p. 57)

2 Press and hold the desired QUICK SELECT until “Quick* Memory” appears on the display.

The current settings will be memorized.



* is displayed the number for the QUICK SELECT button you pressed.





Menu map

When using menu operations, connect this unit to a TV and operate this unit while viewing the TV.



The recommended settings are configured for this unit by default. You can customize this unit based on your existing system and your preferences.

Setting items	Detailed items	Description	Page
 Audio	Surr.Parameter	Adjusts surround sound parameters.	71
	Restorer	Expands the low and high frequency components of compressed audio content such as MP3 files to enable richer audio playback.	74
	Audio Delay	Compensates for incorrect timing between video and audio.	75
	Volume	Make volume settings.	75
 Video	HDMI Audio Out	Select HDMI audio output device.	77
	HDMI PassThrough	Selects how this unit will pass HDMI signals to the HDMI output in standby power mode.	77
	Pass Source	Sets the HDMI connector that inputs HDMI signals when in standby.	78
	HDMI Control	You can link operations with devices connected to HDMI and compatible with HDMI Control.	78
	ARC	On the TV connected to the HDMI MONITOR connector, set whether to receive sound from the TV via HDMI.	79
	TV Audio Switching	Sets automatic switching to the “TV Audio” input when a TV connected via HDMI sends an appropriate CEC control command to this unit.	79
	Pow.Off Control	Links the power standby of this unit to external devices.	80



Setting items	Detailed items	Description	Page
 Inputs	Input Assign	Changes input connector assignment.	81
	Source Level	Adjusts the playback level of the audio input.	81
	Input Select	Sets the audio input mode and decode mode.	82
 Speakers	Speaker Config.	Select whether or not speakers are present, playback capacity for low bass frequencies and speaker size.	83
	Distances	Set distance from listening position to speakers	84
	Levels	Set the volume of the test tone to be the same at the listening position when it is output from each speaker.	85
	Crossovers	Set in accordance with the lower limit frequency of the base frequencies that can be played back through each speaker.	85
	Bass	Set subwoofer and LFE signal range playback.	86



Setting items	Detailed items	Description	Page
 General	Language	Changes the language of the display on the TV screen.	87
	ECO	Configures the ECO Mode and Auto Standby energy-saving functions.	87
	Bluetooth	Configures the Bluetooth settings.	89
	Front Display	Makes settings related to the display on this unit.	90
	Setup Lock	Protects settings from inadvertent changes.	90
	Reset	Various settings are reset to the factory default values.	91
 Setup Assistant	Begin Setup...	Performs basic installation/connections/settings from the beginning according to the guidance indicated on the TV screen.	Page 7 of the separate manual "Quick Start Guide"



Menu operations

1 Press **SETUP**.

The menu is displayed on the TV screen.

2 Use **Δ∇** to select the menu to be set or operated, then press **ENTER**.

3 Use **◀▶** to change to desired setting.

4 Press **ENTER** to enter the setting.

- To return to the previous item, press **BACK**.
- Exiting the menu, press **SETUP** while the menu is displayed. The menu display disappears.

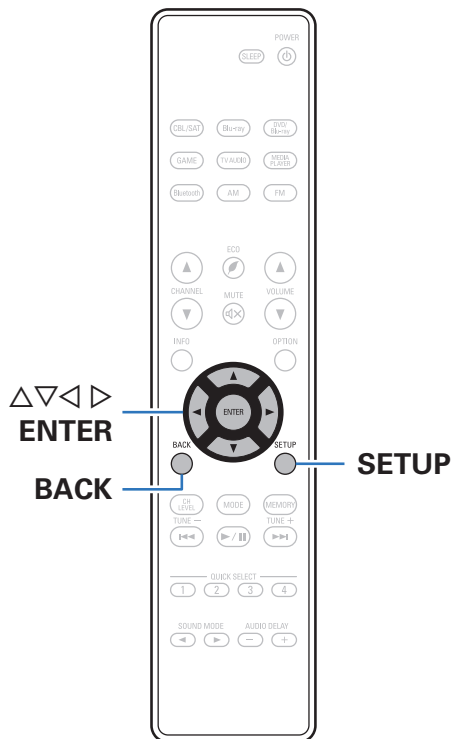

Audio

Make audio-related settings.

Surr.Parameter

You can adjust the surround audio sound field effects to match your preferences.

The items (parameters) that can be adjusted depend on the signal being input and the currently set sound mode. For details on the adjustable parameters, see “Sound modes and surround parameters” (🔍 p. 112).



- Some setting items cannot be set while playback is stopped. Make the settings during playback.
- “Surr.Parameter” settings are stored for each sound mode.

■ Mode

Set the sound mode according to the input signal.

□ Dolby PLII Mode

Movie :	Switches to the sound mode suitable for enjoying movies and TV programs.
Music :	Switches to the sound mode suitable for enjoying music.
Game :	Switches to the sound mode suitable for enjoying games.
Pro Logic :	Dolby Pro Logic playback mode.

□ DTS Neo: 6 mode

Cinema :	Switches to the sound mode suitable for enjoying movies and TV programs.
Music :	Switches to the sound mode suitable for enjoying music.



- “Music” mode is also effective for video sources that contain a lot of stereo music.



■ Dynamic Comp.

Compress dynamic range (difference between loud and soft sounds).

Auto:	Automatic dynamic range compression on/off control according to source.
Low / Medium / High:	These set the compression level.
Off:	Dynamic range compression is always off.



- “Auto” can only be set when Dolby TrueHD signals are input.

■ Low Frequency

Adjust the low frequency effects level (LFE).

-10 dB – 0 dB (Default : 0 dB)



- For proper playback of the different sources, we recommend setting to the values below.
 - Dolby Digital sources : 0 dB
 - DTS movie sources : 0 dB
 - DTS music sources: -10 dB

■ Center Image

Distributes the dialogue output from the center channel to the front left and right channels and widens the sound image in the front.

0.0 – 1.0 (Default : 0.3)



- You can set this when the sound mode is DTS Neo:6 in the “Music” mode.
- The smaller the value, the more dialogue is concentrated on the center channel. The larger the value, the more dialogue is distributed to front left and right channels, and the more the sound image widens in the front.



■ Panorama

The front sound field is expanded further towards the back to create a seamlessly inclusive sound impression.

On: Use "Panorama".

Off
(Default): Do not use "Panorama".



- You can set this when the sound mode is Dolby PLII in the "Music" mode.

■ Dimension

Shift sound image center to front or rear to adjust playback balance.

0 – 6 (Default : 3)



- You can set this when the sound mode is Dolby PLII in the "Music" mode.
- As you set a smaller number, the surround sound field shifts backward; as you set a larger number, the surround sound field shifts forward.

■ Center Width

Distributes the dialogue output from the center channel to left and right channels and widens the sound image in the front.

0 – 7 (Default : 3)



- You can set this when the sound mode is Dolby PLII in the "Music" mode.
- The smaller the value, the more dialogue is concentrated on the center channel. The larger the value, the more dialogue is distributed to front left and right channels, and the more the sound image widens in the front.



■ Subwoofer

Turn subwoofer output on and off.

On (Default):	The subwoofer is used.
Off:	The subwoofer is not used.



- This can be set when the surround mode is set to "Direct" or "Stereo".

■ Set Defaults

The "Surr.Parameter" settings are returned to the default settings.

Restorer

Compressed audio formats such as MP3, WMA (Windows Media Audio) and MPEG-4 AAC reduce the amount of data by eliminating signal components that are hard for the human ear to hear. The "Restorer" function generates the signals eliminated upon compression, restoring the sound to conditions near those of the original sound before compression. It also restores the original bass characteristics for a rich and expanded tonal range.

On:	Use "Restorer".
Off (Default):	Do not use "Restorer".



- This item can be set with analog signals or PCM signal (Sample Rate = 44.1/48 kHz) is input.
- This cannot be set when the sound mode is set to "Direct".
- "Restorer" settings are stored for each input source.



Audio Delay

Compensates for incorrect timing between video and audio.

0 ms – 200 ms (Default : 0 ms)



- “Audio Delay” settings are stored for each input source.
- The “Audio Delay” settings can be set even if AUDIO DELAY + or AUDIO DELAY - is pressed on the remote control unit.

Volume

Make volume settings.

Scale

Set how volume is displayed.

0 - 98
(Default): Display in the range 0 (Min) to 98.

-79.5 dB – 18.0 dB: Display ---dB (Min), in the range -79.5 dB to 18.0 dB.

Limit

Make a setting for maximum volume.

60 (-20 dB) / 70 (-10 dB) / 80 (0 dB)

Off(Default)



- The dB value is displayed when the “Scale” setting is “ -79.5 dB – 18.0 dB”.
( p. 75)

Power On Level

Define the volume setting that is active when the power is turned on.

Last
(Default): Use the memorized setting from the last session.

Mute: Always use the muting on condition when power is turned on.

1 – 98 (-79 dB – 18 dB) : The volume is adjusted to the set level.



- The dB value is displayed when the “Scale” setting is “ -79.5 dB – 18.0 dB”.
( p. 75)



■ Mute Level

Set the amount of attenuation when muting is on.

Full (Default):	The sound is muted entirely.
-40 dB :	The sound is attenuated by 40 dB down.
-20 dB :	The sound is attenuated by 20 dB down.



Video

Make settings for HDMI Audio Out, HDMI PassThrough and HDMI Control settings.

NOTE

- When “HDMI PassThrough” and “HDMI Control” is set to “On”, it consumes more standby power. (“HDMI PassThrough” (🔧 p. 77), “HDMI Control” (🔧 p. 78)) If you are not using this unit for an extended period, it is recommended that you unplug the power cord from the power outlet.

HDMI Audio Out

Select HDMI audio output device.

AVR (Default):	Play back through speakers connected to the unit.
TV:	Play back through TV connected to the unit.



- When the HDMI control function is activated, priority is given to the TV audio setting. (🔧 p. 61)
- When the power of this unit is on and “HDMI Audio Out” is set to “TV”, audio is output as 2-channel from the HDMI OUT connector.

HDMI PassThrough

Selects how this unit will transmit HDMI signals to the HDMI output in standby power mode.

On:	Transmits the selected HDMI input through this unit's HDMI output when this unit is in standby power mode.
Off (Default):	No HDMI signals are transmitted through this unit's HDMI output in standby power mode.



Pass Source

Sets the HDMI connector that inputs HDMI signals when in standby.

Last (Default): The most recently used input source will go into standby mode.

CBL/SAT / DVD/Blu-ray / Game / Media Player: Pass through the selected input source.



- “Pass Source” can be set when “HDMI PassThrough” is set to “On” or “HDMI Control” is set to “On”. (“HDMI PassThrough” (🔍 p. 77), “HDMI Control” (🔍 p. 78))

HDMI Control

You can link operations with devices connected to HDMI and compatible with HDMI Control.

On: Use HDMI control function.

Off (Default): Do not use HDMI control function.



- Please consult the operating instructions for each connected device to check the settings.
- Refer to “HDMI control function” for more information about the HDMI control function. (🔍 p. 61)

NOTE

- If the “HDMI Control” settings have been changed, always reset the power to connected devices after the change.



ARC

On the TV connected to the HDMI MONITOR connector, set whether to receive sound from the TV via HDMI.

On:	Use ARC function.
Off (Default):	Do not use ARC function.



- You can adjust the volume of this unit using the TV remote control.
- If using this function, use a TV compatible with ARC (Audio Return Channel) and enable the HDMI control function of the TV.
- When "HDMI Control" is set to "On", the "ARC" settings automatically switch "On". (🔗 p.78)

NOTE

- If the "ARC" settings have been changed, always reset the power to connected devices after the change.

TV Audio Switching

Sets automatic switching to the "TV Audio" input when a TV connected via HDMI sends an appropriate CEC control command to this unit.

On (Default):	Select the "TV Audio" input automatically when receiving a command from the TV.
Off:	Do not select the "TV Audio" input automatically when receiving a command from the TV.



- "TV Audio Switching" can be set when "HDMI Control" is set to "On". (🔗 p.78)



Pow.Off Control

Links the power standby of this unit to external devices.

All (Default):	If power to a connected TV is turned off independently of the input source, power to this unit is automatically set to standby.
Video:	With an input source being selected that is equipped "HDMI", when you turn the power of the TV off, power to this unit is automatically set to standby.
Off:	This unit does not link with power to a TV.



- "Pow.Off Control" can be set when "HDMI Control" is set to "On". (🔍 p. 78)



Inputs

Perform settings related to input source playback.

You do not have to change the settings to use the unit. Make settings when needed.

Input Assign

By making connections as indicated by the input sources printed on the audio/video input connectors of this unit, you can just press one of the input source select buttons to easily play back audio or video from a connected device.

Please change the assignment of the digital audio input connector when connecting an input source that differs from that printed to the digital audio input terminals of this unit.

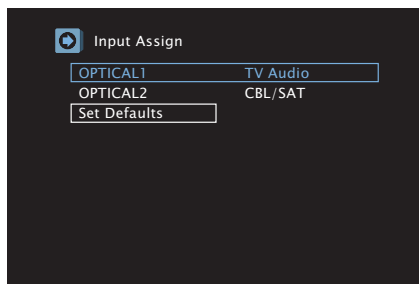

- By default, each item is set as follows.

Input source Input connector	CBL/ SAT	DVD/ Blu- ray	Media Player	Blu- ray	Game	TV Audio
OPTICAL1						<input type="radio"/>
OPTICAL2	<input type="radio"/>					

Set Defaults

The “Input Assign” settings are returned to the default settings.

Source Level

This function corrects the playback level of the selected input source’s audio input.

Make this setting if there are differences in the input volume levels between the different sources.

-12 dB – +12 dB (Default : 0 dB)



- “Source Level” settings are stored for each input source.



Input Select

Set the audio input mode and decode mode of each input source.
The input modes available for selection may vary depending on the input source.





- "Input Select" settings are stored for each input source.

Input Mode

Set the audio input modes for the different input sources.
It is normally recommended to set the audio input mode to "Auto".

Auto (Default):	Automatically detect input signal and perform playback.
HDMI:	Play only signals from HDMI input.
Digital:	Play only signals from digital audio input.
Analog:	Play only signals from analog audio input.



- When digital signals are properly input, the  indicator lights on the display. If the  indicator does not light, check "Input Assign" and the connections. ( p. 81)
- If "HDMI Control" is set to "On" and a TV compatible with the ARC is connected via the HDMI MONITOR connectors, the input mode whose input source is "TV Audio" is fixed to ARC.

Decode Mode

Set the audio decode mode for input source.
It is normally recommended to set the audio input mode to "Auto". But we recommend changing it to "PCM" or "DTS" if the start of the source is clipped or noise occurs.

Auto (Default):	Detect type of digital audio input signal and decode and play automatically.
PCM:	Decode and play only PCM input signals.
DTS:	Decode and play only DTS input signals.



- This item can be set for input sources for which the HDMI input connector is assigned or for which "OPTICAL1" or "OPTICAL2" is assigned under "Input Assign" in the menu. ( p. 81)



Speakers

For optimum surround playback, adjustment of the distance of speakers and sound level of each channel, using text tone, are required, depending on the environment for speakers to be used.

Speaker Config.

Select whether or not speakers are present, playback capacity for low bass frequencies and speaker size.

■ Front

Set the front speaker size.

Large (Default):	Use a large speaker that can adequately play back very low bass frequencies.
Small:	Use a small speaker that has inadequate playback capacity for very low bass frequencies.



- When “Subwoofer” is set to “No”, “Front” is automatically set to “Large”.
- When “Front” is set to “Small”, “Center” and “Surround” can not be set to “Large”.



Center

Set the presence and size of the center speaker.

Large:	Use a large speaker that can adequately play back very low bass frequencies.
Small (Default):	Use a small speaker that has inadequate playback capacity for very low bass frequencies.
None:	Select when a center speaker is not connected.

Subwoofer

Set the presence of a subwoofer.

Yes (Default):	Use a subwoofer.
No:	Select when a subwoofer is not connected.

Surround

Set the presence and size of the surround speakers.

Large:	Use a large speaker that can adequately play back very low bass frequencies.
Small (Default):	Use a small speaker that has inadequate playback capacity for very low bass frequencies.
None:	Select when the surround speakers are not connected.

Distances

Set distance from listening position to speakers.

Measure beforehand the distance from the listening position to each speaker.

Step

Set the unit of distance.

0.1 m / 0.01 m (Default: 0.1 m)

Set Defaults

The “Distances” settings are returned to the default settings.

Set the distance

0.00 m - 18.00 m



- The speakers that can be selected differ depending on the “Speaker Config.” settings. (🔗 p. 83)
- Default settings:
Front L / Front R / Center / Subwoofer: 3.60 m
Surround L / Surround R: 3.00 m
- Set the difference in the distance between the speakers to less than 6.00 m.



Levels

Set the volume of the test tone to be the same at the listening position when it is output from each speaker.

■ Test Tone Start

A test tone is output from the selected speaker.

While listening to the test tone, adjust the volume output from the selected speaker.

-12.0 dB – +12.0 dB (Default : 0.0 dB)



- The set “Levels” are reflected in all sound modes.
- When headphones are connected to the PHONES connector on this unit, you cannot set “Levels”.

■ Set Defaults

The “Levels” settings are returned to the default settings.

Crossovers

Set in accordance with the lower limit frequency of the base frequencies that can be played back through each speaker.

■ Set the crossover frequency

40 Hz / 60 Hz / 80 Hz / 90 Hz / 100 Hz / 110 Hz / 120 Hz / 150 Hz / 200 Hz / 250 Hz (Default : 80 Hz)



- “Crossovers” can be set when the “Subwoofer Mode” setting is “LFE+Main”, or when you have a speaker that is set to “Small”. (🔍 p. 86)
- The default crossover frequency is “80 Hz”, which will work best with the widest variety of speakers. We recommend setting to a higher frequency that the crossover frequency when small speakers are used. For example, set to “250 Hz” when the frequency range of the speakers is 250 Hz – 20 kHz.
- Sounds below crossover frequency is cut off in the output from the speaker set up in “Small”. The cut off bass frequencies is output from the sub-woofer or front speaker.



Bass

Set subwoofer and LFE signal range playback.

■ Subwoofer Mode

Select low range signals to be reproduced by subwoofer.

LFE:	The low range signal of the channel set to "Small" speaker size is added to the LFE signal output from the subwoofer.
LFE+Main (Default):	The low range signal of all channels is added to the LFE signal output from the subwoofer.



- "Subwoofer Mode" can be set when "Speaker Config." - "Subwoofer" is set to other than "No". (☞ p. 84)
- Play music or a movie source and select the mode offering the strongest bass.
- If "Speaker Config." - "Front" and "Center" are set to "Large", and "Subwoofer Mode" is set to "LFE", no sound may be output from the subwoofers, depending on the input signal or selected sound mode. (☞ p. 83)
Select "LFE+Main" if you want the bass signals to always be produced from the subwoofer.

■ LPF for LFE

Set LFE signal playback range. Set this when you want to change the playback frequency (low pass filter point) of the subwoofer.

80 Hz / 90 Hz / 100 Hz / 110 Hz / 120 Hz / 150 Hz /
200 Hz / 250 Hz (Default: 120 Hz)



General

Make various other settings.

Language

Set the language for display the menu on the TV screen.

English / Français / Español (Default : English)



- “Language” can also be set up by the following operation. However, the menu screen is not displayed. Watch the display while configuring the settings.
 1. Press and hold the main unit’s TUNE +, TUNE - and DIMMER for at least 3 seconds.
“V.Format:< PAL >” appears on the display.
 2. Press the main unit’s STATUS.
“Lang.:<ENGLISH >” appears on the display.
 3. Use the main unit’s TUNER PRESET CH + or DIMMER and set the language.
 4. Press TUNE - to enter the setting.

ECO

Configure the settings of the ECO Mode and auto standby mode.

■ ECO Mode

This mode can reduce the power consumption when the power of the unit is on.

On:	The power consumption is always reduced, regardless of the volume.
Auto (Default):	The power consumption is automatically reduced to match the volume.
Off:	Do not reduce the power consumption.



- When you want to output audio at a high volume level, it is recommended to set “ECO Mode” to “Off”.
- Eco mode can also be switched by pressing ECO  on the remote control unit.



■ Pow.On Default

Set the mode to ECO when the power is on.

Last (Default):	The ECO Mode will be set to the previous setting before the power was switched off.
On:	When power is turned on, the mode will always be switched to the “ECO Mode” in “On”.
Auto:	When power is turned on, the mode will always be switched to the “ECO Mode” in “Auto”.
Off:	When power is turned on, the mode will always be switched to the “ECO Mode” in “Off”.

■ Auto Standby

Set so the unit power automatically switches to standby.

Sets the time for switching to auto standby when there are no audio or video signals input into this unit.

Before the unit enters standby mode, “Auto Standby” is displayed on the unit display and the menu screen.

60 min:	The unit goes into standby after 60 minutes.
30 min:	The unit goes into standby after 30 minutes.
15 min (Default):	The unit goes into standby after 15 minutes.
Off:	The unit does not go into standby automatically.



Bluetooth

Configures the Bluetooth settings.

■ BluetoothStandby

Set whether or not to turn the unit's power on when a Bluetooth device is operated.

On: Turns the Bluetooth standby function on.

Off (Default): Turns the Bluetooth standby function off.



- When the "BluetoothStandby" setting is "On" and the connection operation is performed on a Bluetooth device when this unit is in the standby state, this unit's power automatically switches on. In order to use this operation, the device needs to be paired with this unit in advance.

■ Auto-Select

Set whether to automatically switch the source input to "Bluetooth" when performing the connection operation from a Bluetooth device.

On (Default): Select the "Bluetooth" source input automatically when a Bluetooth device connects to this unit.

Off: Do not select to the "Bluetooth" source input when a Bluetooth device connects to this unit.



- Some Bluetooth devices may automatically connect to this unit when they enter this unit's communication range. If this happens, setting "Auto-Select" to "Off" will prevent unintended actions such as turning on this unit or switching the source input to "Bluetooth".



Front Display

Adjust the display brightness of this unit.

■ Dimmer

Bright (Default):	Normal display brightness.
Dim:	Reduced display brightness.
Dark:	Very low display brightness.
Off:	Turns the display off.



- When the display brightness is set to “Off”, the display turns off as in the standby state.
- You can also adjust the display by pressing DIMMER on the main unit.

Setup Lock

Protect settings from inadvertent changes.

■ Lock

On:	Turn protection on.
Off (Default):	Turn protection off.



- Perform the following operations to set “Lock” to “Off”.
 1. Press and hold SETUP for more than 3 seconds.
“Setup Lock:◀On▶” appears on the display.
 2. Use <|> to select “Off”, then press ENTER.

NOTE

- When “Lock” is set to “On”, no setting items are displayed except for “Setup Lock”.



Reset

All settings are reset to the factory default values.



- The “Reset” operation can also be performed by using the button on the main unit. For details on resetting all of the settings to the factory defaults see “Resetting factory settings” ( [p. 106](#)).



Checking the information

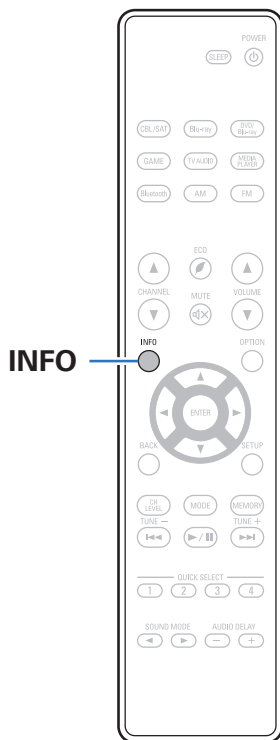

Information on the main unit's various settings (Status) and on input signals (Audio Input Signal) is shown on the display.

1 Press INFO.

The information screen is displayed.



- Press INFO to display current input source name, volume, sound mode, and other information at the bottom of the screen.

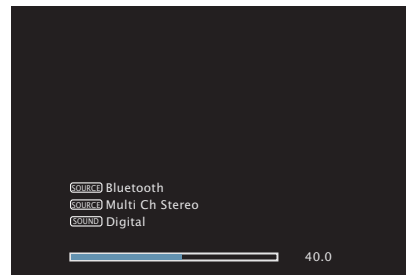

NOTE

- The status display screen cannot be displayed when playing the following video signals.
 - Computer resolution video
 - Video with an aspect ratio other than 16:9 or 4:3



■ Contents

Tips

I want the volume not to become too loud by mistake	94
I want to keep the volume at the same level when I turn the power on	94
I want to have the subwoofer always output audio	94
I want to combine a desired video with the current music	94

Troubleshooting

Power does not turn on / Power is turned off	96
Operations cannot be performed through the remote control unit	97
Display on this unit shows nothing	97
No sound comes out	98
Desired sound does not come out	99
Sound is interrupted or noise occurs	101
No video is shown on the TV	102
The menu screen is not displayed on the TV	103
Bluetooth cannot be played back	104
The HDMI control function does not work	105



Tips

I want the volume not to become too loud by mistake

- Set the volume upper limit for “Limit” in the menu beforehand. This prevents children or others from increasing the volume too much by mistake. (🔍 p. 75)

I want to keep the volume at the same level when I turn the power on

- By default, the volume setting when power was previously set to standby on this unit is applied at next power on with no change. To use a fixed volume level, set the volume level at power on for “Power On Level” in the menu. (🔍 p. 75)

I want to have the subwoofer always output audio

- Depending on the input signals and sound mode, the subwoofer may not output audio. When “Subwoofer Mode” in the menu is set to “LFE+Main”, you can have the subwoofer always output audio. (🔍 p. 86)

I want to combine a desired video with the current music

- Set “Video Select” in the option menu to “On”. You can combine the current music with your desired video source from a Set-top Box or DVD, etc. while listening to music from Tuner. (🔍 p. 56)



Troubleshooting

If a problem should arise, first check the following:

1. **Are the connections correct?**
2. **Is the set being operated as described in the owner's manual?**
3. **Are the other devices operating properly?**



- If steps 1 to 3 above do not improve the problem, restarting the device may improve the problem.
Continue pressing the  button on the unit until "Restart" appears in the display, or remove and re-insert the power cord of the unit.

If this unit does not operate properly, check the corresponding symptoms in this section.

If the symptoms do not match any of those described here, consult your dealer as it could be due to a fault in this unit. In this case, disconnect the power immediately and contact the store where you purchased this unit.



■ Power does not turn on / Power is turned off

Symptom	Cause / Solution	Page
Power does not turn on.	<ul style="list-style-type: none"> Check whether the power plug is correctly inserted into the power outlet. 	<u>35</u>
Power automatically turns off.	<ul style="list-style-type: none"> The sleep timer is set. Turn on the power again. 	<u>63</u>
	<ul style="list-style-type: none"> “Auto Standby” is set. “Auto Standby” is triggered when there is no operation for a set amount of time. To disable “Auto Standby”, set “Auto Standby” on the menu to “Off”. 	<u>88</u>
Power turns off and the power indicator flashes in red approx. every 2 seconds.	<ul style="list-style-type: none"> The protection circuit has been activated due to a rise in temperature within this unit. Turn the power off, wait about an hour until this unit cools down sufficiently, and then turn the power on again. 	<u>118</u>
	<ul style="list-style-type: none"> Please re-install this unit in a place having good ventilation. 	—
Power turns off and the power indicator flashes in red approx. every 0.5 seconds.	<ul style="list-style-type: none"> Check the speaker connections. The protection circuit may have been activated because speaker cable core wires came in contact with each other or a core wire was disconnected from the connector and came in contact with the rear panel of this unit. After unplugging the power cord, take corrective action such as firmly re-twisting the core wire or taking care of the connector, and then reconnect the wire. 	<u>22</u>
	<ul style="list-style-type: none"> Turn down the volume and turn on the power again. 	<u>37</u>
	<ul style="list-style-type: none"> This unit’s amplifier circuit has failed. Unplug the power cord and contact our customer service center. 	—



■ Operations cannot be performed through the remote control unit

Symptom	Cause / Solution	Page
Operations cannot be performed through the remote control unit.	• Batteries are worn out. Replace with new batteries.	6
	• Operate the remote control unit within a distance of about 7 m from this unit and at an angle of within 30°.	6
	• Remove any obstacle between this unit and the remote control unit.	—
	• Insert the batteries in the proper direction, checking the ⊕ and ⊖ marks.	6
	• The set's remote control sensor is exposed to strong light (direct sunlight, inverter type fluorescent bulb light, etc.). Move the set to a place in which the remote control sensor will not be exposed to strong light.	—
	• When using a 3D video device, the remote control unit of this unit may not function due to effects of infrared communications between units (such as TV and glasses for 3D viewing). In this case, adjust the direction of units with the 3D communications function and their distance to ensure they do not affect operations from the remote control unit of this unit.	—

■ Display on this unit shows nothing

Symptom	Cause / Solution	Page
Display is off.	• Press the DIMMER button on this unit or remote control unit to set the display brightness to a setting other than "Off".	90



■ No sound comes out

Symptom	Cause / Solution	Page
No sound comes out of speakers.	• Check the connections for all devices.	22
	• Insert connection cables all the way in.	—
	• Check that input connectors and output connectors are not reversely connected.	—
	• Check cables for damage.	—
	• Check that speaker cables are properly connected. Check that cable core wires come in contact with the metal part on speaker terminals.	22
	• Check that a proper input source is selected.	37
	• Adjust the volume.	38
	• Cancel the mute mode.	38
	• Check the digital audio input connector setting.	81
	• Check the digital audio output setting on the connected device. On some devices, the digital audio output is set to off by default.	—
	• When a headphone is plugged into the PHONES jack on the main unit, sound is not output from the speaker terminal and SUBWOOFER connector.	12
No sound comes out when using the DVI-D connection.	• When this unit is connected to a device equipped with a DVI-D connector, no sound is output. Make a separate audio connection.	—



■ Desired sound does not come out

Symptom	Cause / Solution	Page
The volume does not increase.	• The maximum volume is set too low. Set the maximum volume using “Limit” on the menu.	<u>75</u>
	• Appropriate volume correction processing is performed according to the input audio format and settings, so the volume may not reach the upper limit.	—
No sound comes out with the HDMI connection.	• Check the connection of the HDMI connectors.	<u>26</u>
	• When outputting HDMI audio from the speakers, set “HDMI Audio Out” on the menu to “AVR”. To output from the TV, set “TV”.	<u>77</u>
No sound comes out of a specific speaker.	• Check that speaker cables are properly connected.	<u>22</u>
	• Check that a selection other than “None” is set for the “Speaker Config.” setting in menu.	<u>83</u>
	• When the sound mode is “Stereo” and “Virtual”, audio is only output from the front speakers and subwoofer.	—
No sound is produced from subwoofer.	• Check the subwoofer connections.	<u>23</u>
	• Turn on the subwoofer’s power.	—
	• Set “Speaker Config.” - “Subwoofer” on the menu to “Yes”.	<u>83</u>
	• When “Speaker Config.” - “Front” in the menu is set to “Large”, depending on the input signal and the sound mode, no sound may be output from the subwoofer.	<u>83</u>
	• When no subwoofer audio signal (LFE) is included in the input signals, no sound may be output from the subwoofer.	<u>86</u>
	• You can make the subwoofer always output sound by setting the “Subwoofer Mode” to “LFE+Main”.	<u>86</u>
DTS sound is not output.	• Check that the digital audio output setting on the connected device is set to “DTS”.	—
	• Set “Decode Mode” on the menu to “Auto” or “DTS”.	<u>82</u>
Dolby TrueHD, DTS-HD, Dolby Digital Plus audio is not output.	• Make HDMI connections.	<u>30</u>
	• Check the digital audio output setting on the connected device. On some devices, “PCM” is set by default.	—
Dolby PLII mode or DTS Neo:6 mode cannot be selected.	• It cannot be selected when “None” is set for “Speaker Config.” - “Center” and “Surround”.	<u>84</u>
	• Dolby PLII or DTS Neo:6 cannot be selected when using headphones.	—



Symptom	Cause / Solution	Page
"Restorer" cannot be selected.	• Check that an analog signal or PCM signal (Sample Rate = 44.1/48 kHz) is input. For playback of multichannel signals such as Dolby Digital or DTS surround, "Restorer" cannot be used.	74
	• Switch to a sound mode other than "Direct".	57



■ Sound is interrupted or noise occurs

Symptom	Cause / Solution	Page
Noise often occurs in FM/AM broadcasting.	• Change the antenna orientation or position.	<u>33</u>
	• Separate the AM loop antenna from the unit.	—
	• Use an outdoor antenna.	<u>33</u>
	• Separate the antenna from other connection cables.	<u>33</u>
The sounds appear to be distorted.	• Lower the volume.	<u>38</u>
	• Set "Off" to the ECO Mode. When "On" or "Auto" is in the ECO Mode, the audio may be distorted when the playback volume is high.	<u>87</u>



■ No video is shown on the TV

Symptom	Cause / Solution	Page
No picture appears.	• Check the connections for all devices.	<u>26</u>
	• Insert connection cables all the way in.	—
	• Check that input connectors and output connectors are not reversely connected.	—
	• Check cables for damage.	—
	• Match the input settings to the input connector of the TV connected to this unit.	<u>81</u>
	• Check that the proper input source is selected.	<u>37</u>
	• Check the video input connector setting.	<u>81</u>
	• Check that the resolution of the player corresponds to that of the TV.	—
	• Check whether the TV is compatible with copyright protection (HDCP). If connected to a device not compatible with HDCP, video will not be output correctly.	<u>109</u>
	• To enjoy content that is copyright protected by HDCP 2.2, use a playback device and TV compatible with HDCP 2.2 only.	—
No video is shown on the TV with the DVI-D connection.	• To enjoy 4K content or content that is copyright protected by HDCP 2.2, connect the device to the HDMI 3, HDMI 4 or HDMI 5 input connector.	—
	• With the DVI-D connection, on some device combinations, devices may not function properly due to the copy guard copyright protection (HDCP).	<u>109</u>
While the menu is being displayed, no video is shown on the TV.	<ul style="list-style-type: none"> • The video being played will not appear in the background of the menu when the menu is operated during playback of the following video signals. <ul style="list-style-type: none"> - Some images of 3D video contents - 4K video - Computer resolution images (example: VGA) - Video with an aspect ratio other than 16:9 or 4:3 	—



■ The menu screen is not displayed on the TV

Symptom	Cause / Solution	Page
The menu screen or status information screen is not displayed on the TV.	<ul style="list-style-type: none"> The menu screen is only displayed on this unit and a TV connected with an HDMI cable. If this unit is connected to a TV using a different video output connector, operate while watching the display on this unit. 	—
	<ul style="list-style-type: none"> The status information will not appear on the TV when the following video signals are being played. <ul style="list-style-type: none"> - Some images of 3D video content - Computer resolution images (example: VGA) - Video with an aspect ratio other than 16:9 or 4:3 	<u>92</u>
	<ul style="list-style-type: none"> When a 2D video is converted to a 3D video on the TV, the menu screen or status information screen is not properly displayed. 	—



■ Bluetooth cannot be played back

Symptom	Cause / Solution	Page
Bluetooth devices cannot be connected to this unit.	• The Bluetooth function in the Bluetooth device has not been enabled. See the Owner's Manual of the Bluetooth device to enable the Bluetooth function.	—
	• Bring the Bluetooth device near to this unit.	—
	• The Bluetooth device cannot connect with this unit if it is not compatible with the A2DP profile.	—
	• Turn the power of the Bluetooth device off and on again, and then try again.	—
The sound is cut off.	• Bring the Bluetooth device near to this unit.	—
	• Remove obstructions between the Bluetooth device and this unit.	—
	• To prevent electromagnetic interference, locate this unit away from microwave ovens, wireless LAN devices and other Bluetooth devices.	—
	• Reconnect the Bluetooth device.	—



■ The HDMI control function does not work

Symptom	Cause / Solution	Page
The HDMI control function does not work.	<ul style="list-style-type: none">• Check that “HDMI Control” in the menu is set to “On”.	<u>78</u>
	<ul style="list-style-type: none">• You cannot operate devices that are not compatible with the HDMI control function. In addition, depending on the connected device or the settings, the HDMI control function may not work. In this case, operate the external device directly.	<u>61</u>
	<ul style="list-style-type: none">• Check that the HDMI control function setting is enabled on all devices connected to this unit.	<u>61</u>
	<ul style="list-style-type: none">• When you make connection related changes such as connecting an additional HDMI device, the link operation settings may be initialized. Turn off this unit and devices connected via HDMI, and turn them on again.	<u>61</u>





Resetting factory settings

Perform this procedure if the display is abnormal or if operations cannot be performed.

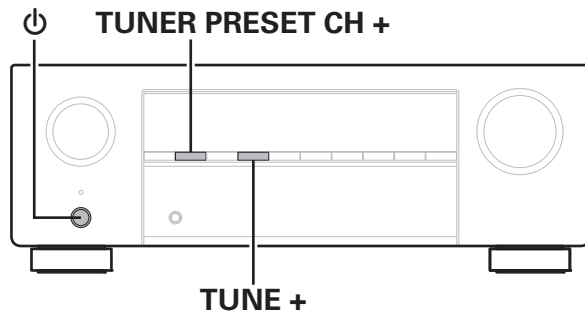
Various settings are reset to the factory default values. Make settings again.



- 1** Turn off the power using .
- 2** Press  while simultaneously pressing TUNER PRESET CH + and TUNE +.
- 3** Release the two buttons when the display starts flashing at intervals of about 1 second.



- You can also reset all settings to the factory defaults using "Reset" in the menu. ( p. 91)



About HDMI

HDMI is an abbreviation of High-Definition Multimedia Interface, which is an AV digital interface that can be connected to a TV or amplifier.

With the HDMI connection, high definition video and high quality audio formats adopted by Blu-ray Disc players (Dolby Digital Plus, Dolby TrueHD, DTS-HD, DTS-HD Master Audio) can be transmitted, which is not possible with the analog video transmission.

Furthermore, in the HDMI connection, audio and video signals can be transmitted through a single HDMI cable, while in conventional connections it is necessary to provide audio and video cables separately for connection between devices. This allows you to simplify the wiring configuration that tends to be quite complex in a home theater system.

This unit supports the following HDMI functions.

- **Deep Color**

An imaging technology supported by HDMI. Unlike RGB or YCbCr, which uses 8 bits (256 shades) per color, it can use 10 bits (1024 shades), 12 bits (4096 shades), or 16 bits (65536 shades) to produce colors in higher definition.

Both devices linked via HDMI must support Deep Color.

- **x.v.Color**

This function lets HDTVs display colors more accurately. It enables display with natural, vivid colors.

“x.v.Color” is trademark of Sony Corporation.

- **3D**

This unit supports input and output of 3D (3 dimensional) video signals of HDMI. To play back 3D video, you need a TV and player that provide support for the HDMI 3D function and a pair of 3D glasses.

- **4K**

This unit supports input and output of 4K (3840 x 2160 pixels) video signals of HDMI.

- **Content Type**

It automatically makes settings suitable for the video output type (content information).

- **Adobe RGB color, Adobe YCC601 color**

The color space defined by Adobe Systems Inc. Because it is a wider color space than RGB, it can produce more vivid and natural images.

- **sYCC601 color**

Each of these color spaces defines a palette of available colors that is larger than the traditional RGB color model.

- **HDMI Pass Through**

Even when the power to this unit is set to standby, signals input from the HDMI input connector are output to a TV or other device that is connected to the HDMI output connector.



- **HDMI Control**

If you connect the unit and an HDMI control function compatible TV or player with an HDMI cable and then enable the HDMI control function setting on each device, the devices will be able to control each other.

- **Power off link**
This unit power off can be linked to the TV power off step.
- **Audio output destination switching**
From the TV, you can switch whether to output audio from the TV or the AV amplifier.
- **Volume adjustment**
You can adjust this unit's volume in the TV volume adjustment operation.
- **Input source switching**
You can switch this unit input sources through linkage to TV input switching.
When playing the player, this unit input source switches to the source for that player.

- **ARC (Audio Return Channel)**

This function transmits audio signals from the TV to this unit through the HDMI cable and plays back the audio from the TV on this unit based on the HDMI control function.

If a TV without the ARC function is connected via HDMI connections, video signals of the playback device connected to this unit are transmitted to the TV, but this unit can not play back the audio from the TV. If you want to enjoy surround audio for TV program, a separate audio cable connection is required.

In contrast, if a TV with the ARC function is connected via HDMI connections, no audio cable connection is required. Audio signals from the TV can be input to this unit through the HDMI cable between this unit and the TV. This function allows you to enjoy surround playback on this unit for the TV.



■ Supported audio formats

2-channel Linear PCM	2-channel, 32 kHz – 192 kHz, 16/20/24 bit
Multi-channel Linear PCM	7.1-channel, 32 kHz – 192 kHz, 16/20/24 bit
Bitstream	Dolby Digital / DTS / Dolby TrueHD / Dolby Digital Plus / DTS-HD Master Audio / DTS-HD High Resolution Audio / DTS Express

■ Supported video signals

- 480i
- 576i
- 720p 60/50Hz
- 1080p 60/50/24Hz
- 480p
- 576p
- 1080i 60/50Hz
- 4K 60/50/30/25/24 Hz

Copyright protection system

In order to play back digital video and audio such as BD video or DVD video via HDMI connection, both this unit and the TV or player must to support the copyright protection system known as HDCP (High-bandwidth Digital Content Protection System). HDCP is copyright protection technology comprised of data encryption and authentication of the connected AV devices. This unit supports HDCP.

- If a device that does not support HDCP is connected, video and audio are not output correctly. Read the owner's manual of your television or player for more information.



- When connecting this unit to a device that is compatible with the Deep Color, 4K and ARC functions, use a "High Speed HDMI cable with Ethernet" that bears the HDMI logo.



Playing back a Bluetooth device

This unit supports the following Bluetooth profile.

- A2DP (Advanced Audio Distribution Profile):
When a Bluetooth device that supports this standard is connected, monaural and stereo sound data can be streamed at a high quality.
- AVRCP (Audio/Video Remote Control Profile):
When a Bluetooth device that supports this standard is connected, the Bluetooth device can be operated from this unit.

■ About Bluetooth communications

Radio waves broadcast from this unit may interfere with the operation of medical devices. Make sure you turn off the power of this unit and Bluetooth device in the following locations as radio wave interference may cause malfunctions.

- Hospitals, trains, aircraft, petrol kiosks and places where flammable gases are generated
- Near automatic doors and fire alarms

Personal memory plus function

The most recently used settings (input mode, HDMI output mode, sound mode, tone control, channel level, Restorer and audio delay, etc.) are saved for each input source.



- “Surr.Parameter” and “Tone” settings are stored for each sound mode.

Last function memory

This function stores the settings which were made before going into the standby mode.



Sound modes and channel output

- This indicates the audio output channels or surround parameters that can be set.
- ◎ This indicates the audio output channels. The output channels depend on the settings of "Speaker Config.". (🔍 p. 83)

Sound mode	Channel output			
	Front L/R	Center	Surround L/R	Subwoofer
Direct (2-channel)	○			◎*
Direct (Multi-channel)	○	◎	◎	◎
Stereo	○			◎
Multi Ch In	○	◎	◎	◎
Dolby Pro Logic II	○	◎	◎	◎
DTS Neo:6	○	◎	◎	◎
Dolby Digital	○	◎	◎	◎
Dolby Digital Plus	○	◎	◎	◎
Dolby TrueHD	○	◎	◎	◎
DTS Surround	○	◎	◎	◎
DTS 96/24	○	◎	◎	◎
DTS-HD	○	◎	◎	◎
DTS Express	○	◎	◎	◎
Multi Ch Stereo	○	◎	◎	◎
Virtual	○			◎

* Audio is output when "Subwoofer Mode" in the menu is set to "LFE+Main". (🔍 p. 86)



Sound modes and surround parameters

Sound mode	Surr.Parameter							Tone	Restorer *3	
	Mode	Dynamic Comp. *1	Low Frequency *2	Subwoofer	Pro Logic II Music mode only					Neo:6 Music mode only
					Panorama	Dimension	Center Width			Center Image
Direct (2-channel)		<input type="radio"/>		<input type="radio"/> *4						
Direct (Multi-channel)		<input type="radio"/>	<input type="radio"/>							
Stereo		<input type="radio"/>	<input type="radio"/>	<input type="radio"/>				<input type="radio"/>	<input type="radio"/>	
Multi Ch In			<input type="radio"/>					<input type="radio"/>		
Dolby Pro Logic II	<input type="radio"/>	<input type="radio"/>			<input type="radio"/>	<input type="radio"/>	<input type="radio"/>	<input type="radio"/>	<input type="radio"/>	
DTS Neo:6	<input type="radio"/>	<input type="radio"/>					<input type="radio"/>	<input type="radio"/>	<input type="radio"/>	
Dolby Digital		<input type="radio"/>	<input type="radio"/>					<input type="radio"/>		
Dolby Digital Plus		<input type="radio"/>	<input type="radio"/>					<input type="radio"/>		
Dolby TrueHD		<input type="radio"/>	<input type="radio"/>							
DTS Surround		<input type="radio"/>	<input type="radio"/>					<input type="radio"/>		
DTS 96/24		<input type="radio"/>	<input type="radio"/>					<input type="radio"/>		
DTS-HD		<input type="radio"/>	<input type="radio"/>							
DTS Express		<input type="radio"/>	<input type="radio"/>					<input type="radio"/>		
Multi Ch Stereo		<input type="radio"/>	<input type="radio"/>					<input type="radio"/>	<input type="radio"/>	
Virtual		<input type="radio"/>	<input type="radio"/>					<input type="radio"/>	<input type="radio"/>	

*1 This item can be selected when Dolby Digital or DTS signal is played.

*2 This item can be selected when Dolby Digital or DTS signal or DVD-Audio is played.

*3 This item can be set when the input signal is analog, PCM 48 kHz or 44.1 kHz.

*4 This setting is available when "Subwoofer Mode" in the menu is set to "LFE+Main". (🔍 p. 86)



Types of input signals, and corresponding sound modes

- This indicates the default sound mode.
○ This indicates the selectable sound mode.

Sound mode	Type and format of input signals											
	ANALOG	PCM		DTS-HD		DTS			Dolby		Dolby Digital	
		PCM (Multi-channel)	PCM (2-channel)	DTS-HD Master Audio	DTS-HD High Resolution Audio	DTS Express	DTS (5.1-channel)	DTS 96/24	Dolby TrueHD	Dolby Digital Plus	Dolby Digital (5.1-channel)	Dolby Digital (2-channel)
DTS Surround												
DTS-HD MSTR				●								
DTS-HD HI RES					●							
DTS Surround						●						
DTS 96/24							●					
DTS Express						●						
DTS Neo:6 Cinema	○		○			○						○
DTS Neo:6 Music	○		○									○
Dolby Surround												
Dolby TrueHD									●			
Dolby Digital Plus										●		
Dolby Digital											●	
Dolby Pro Logic II Movie	○		○									●
Dolby Pro Logic II Music	○		○									○
Dolby Pro Logic II Game	○		○									○
Dolby Pro Logic	○		○									○
Multi Ch In												
Multi Ch In		●										
Direct												
Direct	○	○	○	○	○	○	○	○	○	○	○	○
Original sound mode												
Multi Ch Stereo	●	○	●				○	○			○	○
Virtual	○	○	○				○	○			○	○
Stereo												
Stereo	○	○	○	○	○	○	○	○	○	○	○	○



Explanation of terms

■ Dolby

Dolby Digital

Dolby Digital is a multi-channel digital signal format developed by Dolby Laboratories.

A total of 5.1-channels are played: 3 front channels (“FL”, “FR” and “C”), 2 surround channels (“SL” and “SR”) and the “LFE” channel for low frequency effects.

Because of this, there is no crosstalk between channels and a realistic sound field with a “three-dimensional” feeling (sense of distance, movement and positioning) is achieved. This delivers a thrilling surround sound experience in the home.

Dolby Digital Plus

Dolby Digital Plus is an improved Dolby Digital signal format that is compatible with up to 7.1-channels of discrete digital sound and also improves sound quality thanks to extra data bit rate performance. It is upwardly compatible with conventional Dolby Digital, so it offers greater flexibility in response to the source signal and the conditions of the playback device.

Dolby Pro Logic II

Dolby Pro Logic II is a matrix decoding technology developed by Dolby Laboratories.

Regular music such as that on CDs is encoded into 5-channels to achieve an excellent surround effect.

The surround channel signals are converted into stereo and full band signals (with a frequency response of 20 Hz to 20 kHz or greater) to create an “immersive” sound image offering a rich sense of presence for all stereo sources.

Dolby TrueHD

Dolby TrueHD is a high definition audio technology developed by Dolby Laboratories, using lossless coding technology to faithfully reproduce the sound of the studio master.

This format provides the facility to support up to 8 audio channels with a sampling frequency of 96 kHz/24 bit resolution and up to 6 audio channels with a sampling frequency of 192 kHz/24 bit resolution.



■ DTS

DTS

This is an abbreviation of Digital Theater System, which is a digital audio system developed by DTS. DTS delivers a powerful and dynamic surround sound experience, and is found in the world's finest movie theaters and screening rooms.

DTS 96/24

DTS 96/24 is a digital audio format enabling high sound quality playback in 5.1-channels with a sampling frequency of 96 kHz and 24 bit quantization on DVD-Video.

DTS Digital Surround

DTS™ Digital Surround is the standard digital surround format of DTS, Inc., compatible with a sampling frequency of 44.1 or 48 kHz and up to 5.1-channels of digital discrete surround sound.

DTS-HD

This audio technology provides higher sound quality and enhanced functionality than the conventional DTS and is adopted as an optional audio for Blu-ray Disc.

This technology supports multi-channel, high data transfer speed, high sampling frequency, and lossless audio playback. Maximum 7.1-channels are supported in Blu-ray Disc.

DTS-HD High Resolution Audio

DTS-HD High Resolution Audio is an improved version of the conventional DTS, DTS-ES and DTS 96/24 signals formats, compatible with sampling frequencies of 96 or 48 kHz and up to 7.1-channels of discrete digital sound. High data bit rate performance provides high quality sound. This format is fully compatible with conventional products, including conventional DTS digital surround 5.1-channel data.

DTS-HD Master Audio

DTS-HD Master Audio is a lossless audio format created by Digital Theater System (DTS). This format provides the facility to support up to 8 audio channels with a sampling frequency of 96 kHz/24 bit resolution and up to 6 audio channels with a sampling frequency of 192 kHz/24 bit resolution. It is fully compatible with conventional products, including conventional DTS digital surround 5.1-channel data.

DTS Neo:6™ Surround

DTS Neo:6™ is a matrix decoding technology for achieving 6.1-channel surround playback with 2-channel sources. It includes “DTS Neo:6 Cinema” suite for playing movies and “DTS Neo:6 Music” suited for playing music.



■ Audio

FLAC (Free Lossless Audio Codec)

FLAC stands for Free lossless Audio Codec, and is a lossless free audio file format. Lossless means that the audio is compressed without any loss in quality.

The FLAC license is as shown below.

Copyright (C) 2000, 2001, 2002, 2003, 2004, 2005, 2006, 2007, 2008, 2009 Josh Coalson

Redistribution and use in source and binary forms, with or without modification, are permitted provided that the following conditions are met:

- Redistributions of source code must retain the above copyright notice, this list of conditions and the following disclaimer.
- Redistributions in binary form must reproduce the above copyright notice, this list of conditions and the following disclaimer in the documentation and/or other materials provided with the distribution.
- Neither the name of the Xiph.org Foundation nor the names of its contributors may be used to endorse or promote products derived from this software without specific prior written permission.

THIS SOFTWARE IS PROVIDED BY THE COPYRIGHT HOLDERS AND CONTRIBUTORS "AS IS" AND ANY EXPRESS OR IMPLIED WARRANTIES, INCLUDING, BUT NOT LIMITED TO, THE IMPLIED WARRANTIES OF MERCHANTABILITY AND FITNESS FOR A PARTICULAR PURPOSE ARE DISCLAIMED. IN NO EVENT SHALL THE FOUNDATION OR CONTRIBUTORS BE LIABLE FOR ANY DIRECT, INDIRECT, INCIDENTAL, SPECIAL, EXEMPLARY, OR CONSEQUENTIAL DAMAGES (INCLUDING, BUT NOT LIMITED TO, PROCUREMENT OF SUBSTITUTE GOODS OR SERVICES; LOSS OF USE, DATA, OR PROFITS; OR BUSINESS INTERRUPTION) HOWEVER CAUSED AND ON ANY THEORY OF LIABILITY, WHETHER IN CONTRACT, STRICT LIABILITY, OR TORT (INCLUDING NEGLIGENCE OR OTHERWISE) ARISING IN ANY WAY OUT OF THE USE OF THIS SOFTWARE, EVEN IF ADVISED OF THE POSSIBILITY OF SUCH DAMAGE.

LFE

This is an abbreviation of Low Frequency Effect, which is an output channel that emphasizes low frequency effect sound. Surround audio is intensified by outputting 20 Hz to 120 Hz deep bass to the system subwoofer(s).

MP3 (MPEG Audio Layer-3)

This is an internationally standardized audio data compression scheme, using the "MPEG-1" video compression standard. It compresses the data volume to about one eleventh its original size while maintaining sound quality equivalent to a music CD.



MPEG (Moving Picture Experts Group), MPEG-2, MPEG-4

These are the names for digital compression format standards used for the encoding of video and audio. Video standards include “MPEG-1 Video”, “MPEG-2 Video”, “MPEG-4 Visual”, “MPEG-4 AVC”. Audio standards include “MPEG-1 Audio”, “MPEG-2 Audio”, “MPEG-4 AAC”.

WMA (Windows Media Audio)

This is audio compression technology developed by Microsoft Corporation.

WMA data can be encoded using Windows Media® Player.

To encode WMA files, only use applications authorized by Microsoft Corporation. If you use an unauthorized application, the file may not work properly.

Sampling frequency

Sampling involves taking a reading of a sound wave (analog signal) at regular intervals and expressing the height of the wave at each reading in digitized format (producing a digital signal).

The number of readings taken in one second is called the “sampling frequency”. The larger the value, the closer the reproduced sound is to the original.

Speaker impedance

This is an AC resistance value, indicated in Ω (ohms). Greater power can be obtained when this value is smaller.

Dialogue normalization function

This function operates automatically during playback of Dolby Digital, Dolby Digital Plus, Dolby TrueHD, DTS or DTS-HD sources. It automatically corrects the standard signal level for individual program sources.

Dynamic range

The difference between the maximum undistorted sound level and the minimum discernible level above the noise emitted by the device.

Downmix

This function converts the number of channels of surround audio to a lower number of channels and plays back according to the system’s configuration.



■ Others

HDCP

When transmitting digital signals between devices, this copyright protection technology encrypts the signals to prevent content from being copied without authorization.

Pairing

Pairing (registration) is an operation that is required in order to connect a Bluetooth device to this unit using Bluetooth. When paired, the devices authenticate each other and can connect without mistaken connections occurring.

When using Bluetooth connection for the first time, you need to pair this unit and the Bluetooth device to be connected.

Protection circuit

This is a function to prevent damage to devices within the power supply when an abnormality such as an overload, excess voltage occurs or over temperature for any reason.



Trademark information



The Bluetooth® word mark and logos are registered trademarks owned by Bluetooth SIG, Inc. and any use of such marks by D&M Holdings Inc. is under license. Other trademarks and trade names are those of their respective owners.



Manufactured under license from Dolby Laboratories. Dolby, Dolby Audio, Pro Logic, and the double-D symbol are trademarks of Dolby Laboratories.



For DTS patents, see <http://patents.dts.com>. Manufactured under license from DTS, Inc. DTS, the Symbol, DTS and the Symbol together, DTS-HD, and the DTS-HD logo are registered trademarks and/or trademarks of DTS, Inc. in the United States and/or other countries. © DTS, Inc. All Rights Reserved.



The terms HDMI and HDMI High-Definition Multimedia Interface, and the HDMI Logo are trademarks or registered trademarks of HDMI Licensing LLC in the United States and other countries.



Specifications

■ Audio section

- Power amplifier

Rated output:

Front:

70 W + 70 W (8 Ω /ohms, 20 Hz – 20 kHz with 0.08 % T.H.D.)

90 W + 90 W (6 Ω /ohms, 1 kHz with 0.7 % T.H.D.)

Center:

70 W (8 Ω /ohms, 20 Hz – 20 kHz with 0.08 % T.H.D.)

90 W (6 Ω /ohms, 1 kHz with 0.7 % T.H.D.)

Surround:

70 W + 70 W (8 Ω /ohms, 20 Hz – 20 kHz with 0.08 % T.H.D.)

90 W + 90 W (6 Ω /ohms, 1 kHz with 0.7 % T.H.D.)

Output connectors:

6 – 16 Ω /ohms

- Analog

Input sensitivity/Input impedance:

200 mV/47 k Ω /kohms

Frequency response:

10 Hz – 100 kHz — +1, –3 dB (Direct mode)

S/N:

98 dB (IHF–A weighted, Direct mode)



■ Tuner section

[FM]

[AM]

(Note: μV at 75 Ω /ohms, 0 dBf = 1×10^{-15} W)**Reception frequency range:**

87.5 MHz – 108.0 MHz

522 kHz – 1611 kHz

Effective sensitivity:1.2 μV (12.8 dBf)18 μV **50 dB sensitivity:**MONO – 2.8 μV (20.2 dBf)**S/N ratio:**

MONO – 70 dB (IHF–A weighted, Direct mode)

STEREO – 67 dB (IHF–A weighted, Direct mode)

Distortion:

MONO – 0.7 % (1 kHz)

STEREO – 1.0 % (1 kHz)

■ Bluetooth section

Communications system:

Bluetooth Version 4.2 + EDR (Enhanced Data Rate)

Transmission power:

Bluetooth Specification Power Class 1

Maximum communication range:

Approx. 30 m in line of sight*

Frequency band:

2.4 GHz

Modulation scheme:

FHSS (Frequency-Hopping Spread Spectrum)

Supported profiles:

A2DP (Advanced Audio Distribution Profile) 1.3

AVRCP (Audio Video Remote Control Profile) 1.5

Corresponding codec:

SBC

Transmission range (A2DP):

20 Hz - 20,000 Hz

*The actual communication range varies depending on the influence of such factors as obstructions between devices, electromagnetic waves from microwave ovens, static electricity, cordless phones, reception sensitivity, antenna performance, operating system, application software etc.



■ General

Power supply: AC 230 V, 50/60 Hz

Power consumption: 300 W

Power consumption in standby modes:

Standby modes	Setting items in the menu		Power consumption
	BluetoothStandby (☞ p. 89)	HDMI PassThrough (☞ p. 77) / HDMI Control (☞ p. 78)	
Normal standby	Off	Off	0.1 W
Bluetooth standby	On	Off	0.5 W
CEC standby	Off	On	0.5 W

For purposes of improvement, specifications and design are subject to change without notice.



■ Dimensions (Unit : mm)

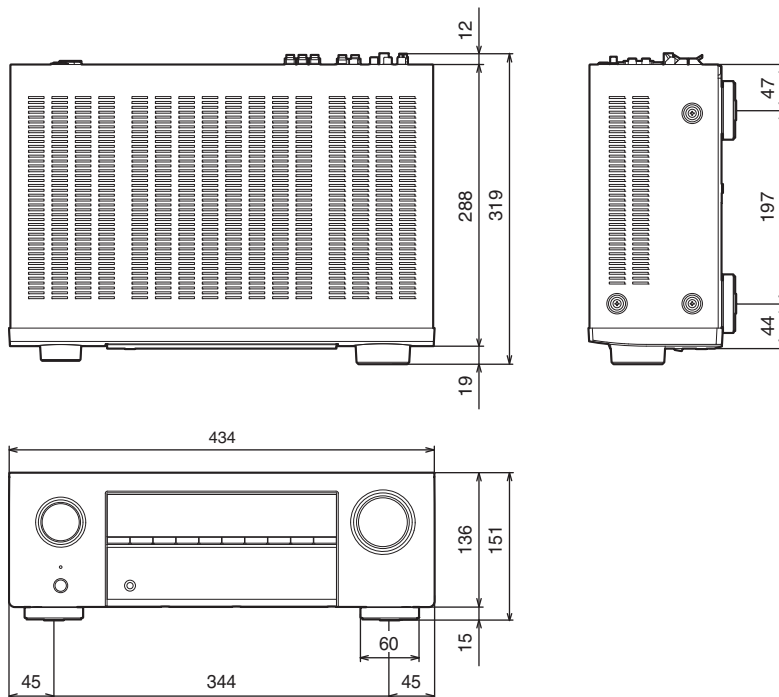

■ Weight: 7.5 kg

Index

Numerics

3D	107
4K	107
5.1-channel	21, 24

A

Audio formats	109
Audio settings	67, 71
Auto Standby	88

B

Bluetooth device	40
Blu-ray Disc player	31, 38

C

Cable TV	30
----------------	----

D

Direct sound mode	59
Display	13
Dolby sound mode	58, 114
DTS sound mode	58, 115
DVD player	31, 38

E

ECO Mode	87
----------------	----

F

FM/AM antenna	33, 45
Front panel	10

G

Game console	32
General settings	69, 87

H

HDCP	109
HDMI Control	61, 78

I

Input Assign	81
Input settings	68, 81
Input signal	113
Input source	37

M

Menu map	67
Muting	38

O

Original sound mode	59
---------------------------	----



**P**

Pairing	40, 42
PCM multi-channel sound mode	58
Protection circuit	118

**R**

Random playback	53
Rear panel	14
Remote control unit	16
Repeat playback	53
Resetting factory settings	106
Restorer	74

**S**

Satellite tuner	30
Set-top box	30
Setup Assistant	69
Sleep timer	63
Sound mode	57, 111, 112
Speaker connection	20
Speaker settings	68, 83
Stereo sound mode	59

**T**

Tips	94
Tone Control	54
Troubleshooting	95
TV	26, 27, 28

**V**

Video camcorder	32
Video Select	56
Video settings	67, 77
Volume	38, 62



DENON[®]

www.denon.com

3520 10580 00AD

Copyright © 2018 D&M Holdings Inc. All Rights Reserved.